

Operating manual
Volume conversion device
EK280

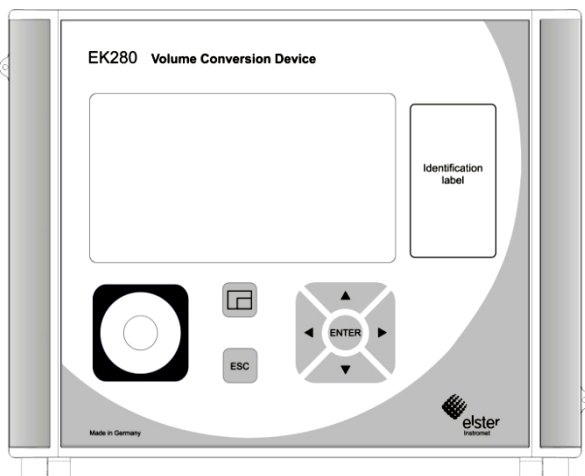

Volume conversion device EK280

Operating manual: 73021209
Version: c
Issue date: 6.9.17
Software-Version: 2.50 or later

Contents

- 1 General..... 7**
 - 1.1 Information about this manual 7
 - 1.2 Warranty provisions 7
 - 1.3 Customer service..... 7
 - 1.3.1 Customer service and repairs7
 - 1.3.2 Electronic hotline8
 - 1.4 Meaning of symbols..... 8
 - 1.4.1 Safety information8
 - 1.4.2 Tips and recommendations9
 - 1.5 Limitationof liability 9
 - 1.6 Copyright protection 9
 - 1.7 Scope of delivery 10
 - 1.8 Spare parts and accessories 10
 - 1.9 Storage 11
- 2 Safety 12**
 - 2.1 General 12
 - 2.2 Intended use 14
 - 2.3 Personnel..... 15
 - 2.4 Personal protective equipment 16
 - 2.5 Specific risks..... 17
 - 2.6 Environmental protection 18
 - 2.7 Operator's responsibility 18
- 3 Technical data 20**
 - 3.1 General data 20
 - 3.2 Power supply for EK280 without integrated power supply unit 20
 - 3.2.1 Battery power supply for the basic device20
 - 3.2.2 Battery power supply for the integrated modem20
 - 3.2.3 External power supply for the basic device21
 - 3.3 Power supply for EK280 with integrated power supply unit 21
 - 3.3.1 Battery power supply for the basic device21
 - 3.3.2 External power supply21
 - 3.3.3 Buffer batteries for the integrated modem21
 - 3.4 Pressure sensor 22
 - 3.4.1 CT30 Type Pressure Sensor22
 - 3.4.2 Pressure Sensor Type 17002.....23
 - 3.5 Temperature sensor 23
 - 3.6 Digital inputs 23
 - 3.6.1 LF pulse and signalinputs23
 - 3.6.2 HF pulse inputs (high frequency)24
 - 3.6.3 Encoder input24
 - 3.7 Digital outputs 25
 - 3.7.1 Nominal data25

3.7.2 LF pulse or signal outputs	25
3.7.3 HF pulse outputs	25
3.8 Interfaces	26
3.8.1 Serial optical interface	26
3.8.2 Serial electrical interface	26
3.8.3 Integrated modem	26
3.9 Measurement conditions.....	27
3.9.1 Environment	27
3.10 Labeling	27
3.10.1 Type label of the volume corrector	27
3.10.2 ATEX marking	28
3.10.3 Device software identification	29
4 Construction and Function	30
4.1 External view.....	30
4.2 Internal view.....	30
4.3 Short description	31
4.4 Connections	31
5 Assembly, Connection and Putting into Operation	32
5.1 Assembly	32
5.1.1 Assembly on a gas meter	33
5.1.2 Assembly on a pipeline	33
5.1.3 Assembly on a wall.....	34
5.1.4 Three-way valve	34
5.2 Connection	35
5.2.1 Connecting the gas meter	36
5.2.2 Sealing the input terminals	38
5.2.3 Connecting the temperature sensor	38
5.2.4 Connecting the pressure pipe.....	40
5.2.5 Connecting the power supply	41
5.2.6 Connect outputs of the EK280.....	43
5.2.7 Earthing the EK280 housing.....	44
5.2.8 Earthing the cable connections of the EK280.....	45
5.2.9 Additional measures for installation in zone 2	45
5.3 Putting into operation	46
5.3.1 Configuration of measurement parameters	46
5.3.2 Sealing	55
5.3.3 Closing the housing.....	57
5.3.4 Verifying assembly and connection	57
6 Operation	58
6.1 Safety	58
6.1.1 Personal protective equipment.....	58
6.2 Operating personnel	58
6.2.1 Instructed personnel.....	58
6.2.2 Qualified personnel	58
6.2.3 Calibration officers.....	59

6.3 Basic principles.....	59
6.3.1 Display	60
6.3.2 Button functions	61
6.3.3 Data recall, display navigation.....	62
6.3.4 Meaning of status symbols	63
6.3.5 Error messages when entering values	65
6.3.6 Access rights.....	66
6.4 Data register content	68
6.4.1 Access rights.....	68
6.4.2 "Main" register (main display).....	68
6.4.3 "Cust." register (Customer)	70
6.4.4 "Admin" register (Administrator)	72
6.4.5 "Serv." register (service).....	73
6.4.6 "Ctrl." register (Control)	74
7 Maintenance	77
7.1 Safety.....	77
7.1.1 Personnel.....	79
7.1.2 Personal protective equipment	79
7.1.3 Environmental protection.....	79
7.2 Testing and changing device batteries	80
7.2.1 Changing and connecting device batteries.....	80
7.2.2 Entering the battery capacity	82
7.2.3 Display remaining battery power	83
8 Faults	84
8.1 Safety.....	84
8.1.1 Personnel.....	84
8.1.2 Personal protective equipment.....	85
8.1.3 Improper elimination of faults	85
8.1.4 Behavior in the event of faults	85
8.2 Fault and other status messages	86
9 Appendix.....	91
9.1 List of spare parts and accessories	91
9.1.1 Fastening elements	91
9.1.2 Pressure connections.....	91
9.1.3 Temperature sensor pockets.....	92
9.1.4 Small parts and miscellaneous.....	92
9.1.5 Documentation	92
9.2 EC Declaration of Conformity	93
9.3 ATEX Type Examination Certificate	94
9.3.1 Zone 1	94
9.3.2 Zone 2	109

1 General

1.1 Information about this manual

This manual allows for safe and efficient use of the device. Compliance with all safety information and instructions for use contained in this operating manual is a prerequisite for safe working processes and proper use of the device. Furthermore, the valid guidelines, standards, local accident prevention regulations, and general safety regulations must be complied with for the respective area of application of the device. This manual forms a constituent part of the product and must be stored within the immediate vicinity of the device and be accessible to installation, service, maintenance, and cleaning personnel at all times. The graphic illustrations used in this manual serve as a visual representation of the described processes and are therefore not necessarily to scale and may deviate from the actual design of the device.



The data and material properties indicated serve as reference values. These must be verified on a case-by-case basis and adjusted as necessary.



The EK280 Application Manual is available for you at www.ek280.de (-> Documents) for the commissioning of the various communication and device applications.

1.2 Warranty provisions

The current warranty provisions can be found in the general terms and conditions online under: <https://www.elster-instromet.com/en/general-terms-of-business>

1.3 Customer service

Our customer service team is responsible for providing technical information and repairs. Our employees are constantly striving to acquire new information and gain experience and these are both valuable sources for improving our products.

1.3.1 Customer service and repairs

- Tel. +49 (0) 61 34 / 605-0
- Fax +49 (0) 61 34 / 605-390
- E-mail: PMT-Reparatur_Mainz-GE4N@honeywell.com

1.3.2 Electronic hotline



In the event of faults, you can also contact the electronic hotline.

- Tel. +49 (0) 6134 / 605-123
- <http://www.elster-instromet.com/de/support>
- E-Mail: ElsterSupport@honeywell.com

1.4 Meaning of symbols

1.4.1 Safety information

In this manual, safety information is denoted by the use of symbols. The safety information is introduced by signal words which identify the level of risk.

This safety information must be complied with and care should be taken to prevent accidents, personal injury, and material damage.



DANGER!

... indicates an imminently dangerous situation which, if not avoided, could lead to death or serious injury.



WARNING!

... indicates a potentially dangerous situation which, if not avoided, could lead to death or serious injury.



CAUTION!

... indicates a potentially dangerous situation which, if not avoided, may lead to minor or slight injuries.



... indicates dangers resulting from electrical current. A non-compliance of the safety information poses a risk of serious or life-threatening injuries.



CAUTION!

... indicates a potentially dangerous situation which, if not avoided, could lead to material damage.

1.4.2 Tips and recommendations



... provides useful tips and recommendations as well as information for ensuring efficient and smooth operations.

1.5 Limitation of liability

All of the information contained in this manual has been compiled under consideration of valid standards and regulations, the latest technological developments, and our many years of experience and expertise. The manufacturer shall accept no liability for damages resulting from:

- Non-compliance of the manual
- Improper use
- Deployment of unqualified personnel
- Unauthorized modifications
- Technical changes
- Use of unauthorized spare parts

The actual scope of delivery may deviate from the information and graphics presented herein due to special designs, the selection of additional ordering options, or the latest technological developments.

The obligations stipulated in the delivery contract, the general terms and conditions and delivery conditions of the manufacturer, and the statutory provisions valid at the time of signing the contract, shall apply.



This manual should be read carefully before commencing all works on and with the device, particularly before putting the device into operation! The manufacturer shall accept no liability for damages and losses arising from non-compliance with the manual.

We reserve the right to make technical changes within the scope of improving usability and further development.

1.6 Copyright protection

This manual is copyright-protected and is intended for internal use only. A transfer of this manual to third parties, a reproduction of any kind, whether partially or fully, and the use and/or disclosure of its content, are not permitted without written consent from the manufacturer, except for internal purposes. Contraventions to this provision shall result in damage compensation. We reserve the right to assert further claims.

1.7 Scope of delivery

The scope of delivery for the EK280 includes:

- Electronic volume conversion device EK280
- Dispatch list
- Design data sheet
- Manual
- Bag of accessories

1.8 Spare parts and accessories



WARNING!

Incorrect use of spare parts and accessories may present a risk to safety!

False or incorrect use of spare parts and accessories may impair safety and lead to damage, malfunctions, or total failures.

Therefore:

- Only use original spare parts and accessories produced by the manufacturer.
- The manufacturer should always be contacted in the event of uncertainty.

A list of spare parts and accessories can be found in the appendix. Spare parts and accessories can be ordered from an authorized retailer or from our customer service team directly.

The free "enSuite" program also belongs to the accessories for the EK280 and is available under www.elster-instromet.com. This can be used to program the EK280 volume conversion device via its data interfaces to perform advanced applications.

The EK280 can be supplied as a calibrated and non-calibrated device and is also available in a number of different models. Further details can be found under www.elster-instromet.com and in the "Assembly, Connection and Putting into Operation" chapter.

1.9 Storage



CAUTION!

Exceeding or falling below the valid temperature range for the batteries may impair performance.

If the valid temperature range of the batteries during storage of the device is exceeded or fallen below, the performance of the batteries may be impaired.

Therefore:

- For long periods of storage, please ensure that the valid temperature range for the fitted batteries does not fall below $-25\text{ }^{\circ}\text{C}$ or exceed $+55\text{ }^{\circ}\text{C}$.



CAUTION!

Material damage caused by the formation of condensation.

Fluctuations in temperature during storage may cause condensation to form. This may lead to subsequent malfunctions of the device.

Therefore:

- After storage or transport in cold weather conditions or after having been exposed to strong temperature fluctuations, the device should slowly be adjusted to the room temperature before being put into operation.
- If condensation has formed, wait at least 12 hours before putting the device into operation.



If the power supply to the device is interrupted during storage due to the batteries being disconnected, the time and date have to be reprogrammed.

The following rules apply for storage:

- The relative humidity should be a maximum of 93%.
- Do not store packages in the open air.
- The storage temperature should not fall below $-25\text{ }^{\circ}\text{C}$ and should not exceed $+55\text{ }^{\circ}\text{C}$.
- Avoid mechanical vibrations during storage of the device.

2 Safety

This chapter gives an overview of all of the most important safety aspects in order to best protect personnel and to ensure a safe and smooth operation of the device. A non-compliance with the safety information and instructions for use specified in this manual could result in serious damage.

2.1 General

The EK280 is an intrinsically safe device as per the ATEX Product Directive 94/9/EC and the ATEX Operating Directive 1999/92/EC EN, and is suitable for operation within the following explosive gas atmospheres:

- EK280 without integrated power supply unit or modem:
Zones 1 and 2 for gases in temperature class T4
- EK280 without integrated power supply unit and with modem:
Zones 1 and 2 for gases in temperature class T3
- EK280 with integrated power supply unit (with or without modem):
Zone 2 for gases in temperature class T6

Verification for use in zone 1 as per the respectively valid technical rules and standards: see chapter 9.3: EC type examination certificate no. LCIE 11 ATEX 3027 X



DANGER!

Using the wrong model presents a risk of explosion!

The EK280 is available in different models for use in zones 1 and 2.

The model designed for zone 2 should not be used in zone 1 as this presents a risk of explosion!

Therefore:

- Before installing the device in zone 1, please check that the EK280 is suitable for use in zone 1.
- The EK280 should only be operated in zone 1, if category "II 1 G" or "II 2 G" have been marked on the ATEX label.
- If category "II 3 G" has been marked on the ATEX label, the EK280 should not be used in zone 1, but only in zone 2.
- The ATEX label is located on the top panel of the EK280 housing.

**DANGER!****The connection of non intrinsically-safe or non-associated equipment presents a risk of explosion!**

Operating the EK280 in zone 1 and connecting devices which are not certified as "associated equipment" present a risk of explosion.

Therefore:

- When using the EK280 in zone 1, it should only be connected to certified associated equipment as per the ATEX Product Directive 94/9/EC.
- The EK280 should only be connected to the intrinsically-safe circuits of associated equipment whose electrical data corresponds to those requirements stipulated in the declaration of conformity for the EK280 (see Appendix).

**DANGER!****Using incorrect batteries presents a risk of explosion!**

Connect only the prescribed Elster battery-types to the device (see chapter 9.1.4 .)



When connecting and operating the EK280 in explosive gas atmospheres, the corresponding standards must be observed:

DIN EN 60079-0

DIN EN 60079-14

The device may only be used in zone 1 or zone 2, if installation has been carried out according to the separate requirements stipulated under DIN EN 60079-14 and the operating conditions (see "Technical Data" chapter) as well as the connection conditions (see "Assembly, Connection and Putting into Operation" chapter).

The device may be dangerous if unqualified personnel use it incorrectly or do not use it according to its intended purpose.

- All of those persons who are charged performing works on or with the device, must have read and understood the manual before commencing such works. This shall also apply if the person in question has already worked with the same or a similar device or has been trained by the manufacturer.

- Being familiar with the content of the manual is a necessary condition for protecting personnel against risks, preventing errors from occurring, and therefore ensuring a safe and smooth operation of the device.
- In order to avoid risks and to ensure optimal performance of the device, neither modifications nor changes should be carried out without express consent from the manufacturer.
- All operating instructions should be kept in a clearly legible condition on the device. Damaged or illegible instructions should be replaced immediately.
- The setting values and value ranges specified in this manual should be complied with.

2.2 Intended use

This device is solely designed and constructed for the intended use described below.

The volume conversion device EK280 is used to convert the gas volume read from a gas pipe under measurement conditions, into base conditions, as well as to allocate the measured quantities to tariffs. Furthermore, the device can also be used to measure, record and monitor additional variables depending on the configuration set by the user.

Intended use also refers to compliance with all of the information contained in this manual. Any use beyond the intended use and/or other types of use, shall be considered as misuse and can result in dangerous situations. The manufacturer shall not be held liable for any claims for damages resulting from misuse of this device.



WARNING!
Danger resulting from misuse.

Misuse of the device may lead to dangerous situations.

Therefore:

- Only use the device according to its intended use.
- Do not use the device to regulate the gas flow or other variables affecting the gas volume in the entire system.

2.3 Personnel



WARNING!

Risk of injury to unqualified personnel.

Improper use of the device may lead to significant personal injury or material damage.

Therefore:

- All works should solely be carried out by qualified personnel.

The following qualifications are used in the manual to denote different areas of responsibility:

■ **Instructed personnel**

will be informed of the tasks assigned to them and possible risks resulting from inappropriate behavior, in a training session provided by the operator.

■ **Qualified personnel**

who, on the basis of their specialist training, knowledge and experience, as well as their awareness of the relevant statutory provisions, are in a position to perform their assigned tasks on the device and are able to independently identify and prevent possible risks.

■ **Gas specialists**

who, on the basis of their specialist training, knowledge and experience, as well as their awareness of the relevant standards and regulations, are in a position to perform works on gas-handling equipment and to independently identify possible risks. The gas specialist will be specially trained in the respective area and will be familiar with the relevant standards and regulations.

■ **Calibration officers**

who, on the basis of their specialist training, knowledge and experience, as well as their awareness of the relevant standards and regulations, are in a position to perform the works subject to calibration regulations on gas-handling equipment. The calibration officer will be trained on works on devices and installations subject to calibration regulations and will be familiar with the relevant standards and regulations.

■ **Electricians**

who, on the basis of their specialist training, knowledge and experience, as well as their awareness of the relevant standards and regulations, are in a position to perform the works on electrical installations and to independently identify and prevent possible risks. The electrician will be specially trained in the respective area and will be familiar with the relevant standards and regulations.



WARNING!
Risk to unauthorized persons!

Unauthorized persons, who do not meet the aforementioned criteria, will not be familiar with the risks in the working area.

Therefore:

- Please keep unauthorized persons away from the working area.
- In cases of doubt, approach said person and direct them out of the working area.
- Interrupt the works if unauthorized persons enter the working area.

Only those persons who can be trusted to reliably execute their works shall be authorized to work on or with the device. People whose reactivity is impaired, e.g. by drugs, alcohol or medication, shall not be authorized to perform such works.

- When selecting personnel, please observe the valid age and professional guidelines for all of the gas-handling equipment.

2.4 Personal protective equipment

When working on the device inside a gas-handling plant, personal protective equipment must be worn to minimize risks to health.

- During works on the device, the necessary personal protective equipment must be worn inside the respective plant at all times
- The notices relating to personal protective equipment mounted in the working area must be followed at all times.

2.5 Specific risks

The residual risks arising from the risk assessment will be listed below. Please observe the safety and warning information specified in the following chapters to reduce risks to health and to prevent dangerous situations from arising.



WARNING!

Misuse of batteries may present a risk of injury.

Special care must be taken when handling batteries.

Therefore:

- Do not throw batteries into the fire or expose these to high temperatures. There is a risk of explosion.
- Do not charge batteries. There is a risk of explosion.
- Liquids that are produced as a result of misuse may lead to skin irritation. Avoid physical contact with such liquid. In the event of contact, rinse with large quantities of water. If the liquid enters the eyes, immediately rinse with water for 10 minutes and seek medical attention.



WARNING!

Risk of fire from highly flammable substances!

Highly flammable substances, liquids or gases could catch fire and lead to serious or fatal injuries.

Therefore:

- Do not smoke within the danger zone or within close proximity to this zone. No naked flames or ignition sources are permitted within this zone.
- Have a fire extinguisher close to hand.
- Suspicious substances, liquids or gases should be reported to the responsible member of staff immediately.
- Work should be stopped immediately in the event of a fire. You should leave the danger zone until it is given the all-clear.

2.6 Environmental protection



CAUTION! **Environmentally hazardous substances!**

If environmentally hazardous substances are handled incorrectly this may cause significant damage to the environment, particularly if they are improperly disposed of.

Therefore:

- The instructions below should be observed at all times.
- Appropriate measures should be taken immediately if environmentally hazardous substances are accidentally released into the environment. In cases of doubt, please inform the responsible local authority about the damages.

The following environmentally hazardous substances are used:

- Batteries

Batteries contain toxic heavy metals. They must be treated as special hazardous waste and be disposed of in municipal waste collection points or by a waste specialist.

2.7 Operator's responsibility

The device will be used in the commercial sector. The operator of the device will therefore be subject to legal obligations concerning occupational safety.

In addition to the safety information contained in these instructions, the valid safety, accident prevention, and environmental protection regulations for the area of application of the device, must be adhered to. In particular:

- The operator must ensure that the valid safety, accident prevention, and environmental protection regulations for the entire plant in which the device is being integrated, are complied with.
- The operator must be familiar with the valid occupational safety regulations and must also be able to conduct a risk assessment to determine risks arising from the specific working conditions in the respective area of application of the device. The operator must then implement this in the form of operating instructions for the operation of the device.
- Throughout the entire life cycle of the device, the operator must determine whether their prepared operating instructions are compatible with current regulations and amend these if and when necessary.
- The operator must clearly regulate and define responsibilities for the assembly, connection, putting into operation, and maintenance of the device.

- The operator must ensure that all employees who use the device have read and understood this manual. Furthermore, the operator must provide training to personnel at regular intervals and inform them of the potential risks.
- The operator of the entire plant in which the device is to be integrated, must provide personnel with the necessary protective equipment.

Furthermore, the operator is responsible for ensuring that the device remains in a perfect functioning order at all times. The following therefore apply:

- The operator must ensure that the installation and maintenance works described in this manual are carried out correctly.
- The operator must regularly have all safety mechanisms checked for their functionality and completeness.

3 Technical data

3.1 General data

Data	Value	Unit
Width (incl. cable glands)	230	mm
Height (incl. cable glands)	180	mm
Depth	115	mm
Permissible ambient temperature range	-25 ... +55	°C
Permissible gas temperature range	-30 ... +60	°C

3.2 Power supply for EK280 without integrated power supply unit

3.2.1 Battery power supply for the basic device

Data	Value	Unit
Voltage	3.6	V
General nominal capacity	16.5	Ah
Usable capacity	13.0	Ah
Minimum number of batteries required	2	units
Minimum operating life (at standard measurement conditions)	5	years

The **standard measurement conditions** are defined as follows:

Data	Value
Measurement cycle	30 seconds
Mode input 1	Pulse input
Display active	60 minutes per month
Interface or modem active	30 minutes per month
Ambient temperature	-10 ... +50°C

3.2.2 Battery power supply for the integrated modem

Data	Value	Unit
Voltage	3.9	V
General nominal capacity	16.0	Ah

3.2.3 External power supply for the basic device

Data	Value	Unit
Supply voltage	7.5 ...8.5	V
Supply current, maximum	40	mA

3.3 Power supply for EK280 with integrated power supply unit

3.3.1 Battery power supply for the basic device

Batteries for switching to battery mode in the event of a power failure: see chapter 3.2.1 "Battery power supply for the basic device"

3.3.2 External power supply

Data	Value	Unit
Supply voltage	230	V ~
Power consumption, maximum	10	W

3.3.3 Buffer batteries for the integrated modem

The buffer batteries can optionally be connected to the integrated power supply unit to ensure that data continues to be transmitted, even in the event of a power failure.

Data	Value	Unit
Voltage	3.6	V
General nominal capacity	13.0	Ah
Usable capacity	8.0	Ah
Minimum number of batteries required	2	units

3.4 Pressure sensor

3.4.1 CT30 Type Pressure Sensor

Data	Value	Unit
External thread	M12 x 1.5	
Usable thread length	approx. 10	mm

3.4.1.1 Absolute pressure ranges

Measuring range	Overload capacity
0.7 ...2 bar abs.	18 bar abs.
0.8 ...5 bar abs.	25 bar abs.
1.4 ...7 bar abs.	25 bar abs.
2.0 ... 10 bar abs.	40 bar abs.
2.4 ... 12 bar abs.	40 bar abs.
4 ... 20 bar abs.	40 bar abs.
6 ... 30 bar abs.	60 bar abs.
8 ... 40 bar abs.	60 bar abs.
14 ... 70 bar abs.	105 bar abs.
16 ... 80 bar abs.	105 bar abs.



The pressure sensor is available as both an external and internal model. Further details can be found under www.elster-instromet.com or chapter "Assembly, Connection and Putting into Operation".

3.4.1.2 Relative pressure ranges

Measuring range	Overload capacity
1.4 ... 7 bar rel.	40 bar rel.
4 ... 20 bar rel.	40 bar rel.
16 ... 80 bar rel.	105 bar rel.



The pressure sensor is only available as an externally connected model and can only be used as a second pressure sensor for non-metrological measurements. Further details can be found under www.elster-instromet.com or chapter "Assembly, Connection and Putting into Operation".

3.4.2 Pressure Sensor Type 17002

Data	Value	Unit
External thread (internal model)	M12 x 1.5	
Usable thread length (internal model)	approx. 10	mm
Measuring range	Overload capacity	
0.9 ... 7 bar abs.	10 bar abs.	



The pressure sensor is available as both an external and internal model. Further details can be found under www.elster-instromet.com or chapter "Assembly, Connection and Putting into Operation".

3.5 Temperature sensor

Data	Value	Unit
Measuring range	-30 ... +60	°C
Measurement uncertainty	max. ± 0.1	%
Installation length	50	mm

3.6 Digital inputs

3.6.1 LF pulse and signalinputs

The maximum counting frequency of the digital inputs can be adjusted using the "enSuite" software. The limit values specified for frequency and duration shall only apply if the so-called "software debounce" has been switched off.

The software debounce is activated ex-works to suppress interference pulses and therefore restrict safe readings to 2 Hz.



If the software debounce is parameterized to a frequency higher than 2 Hz, then it may lead to counting errors caused by electromagnetic interference under certain circumstances.

Data		Value	Unit
Open-circuit voltage U_0		5.0	V
Internal resistance R_I		1	M Ω
Short circuit current I_k		5	μ A
Switch point "ON":	▪ Resistance R_e	max. 100	k Ω
	▪ Voltage U_e	max. 0.8	V
Switch point "OFF":	▪ Resistance R_a	min. 2	M Ω
	▪ Voltage U_a	min. 3	V
Pulse duration t_e		min. 62.5	ms
Pause duration t_a		min. 62.5	ms
Counting frequency f		max. 10	Hz
Counting frequency f for input 3		max. 6	Hz

3.6.2 HF pulse inputs (high frequency)

High frequency pulse transducers can only be connected to inputs 1 and 2 (terminals DE1 and DE2) (see chapter 5.2.1.3).

Data	Value	Unit
Open-circuit voltage	7.5 ... 8.5	V
"High" switching level	max. 1.2	mA
"Low" switching level	min. 2.1	mA
Input frequency	max. 2500	Hz

3.6.3 Encoder input



An encoder can only be connected to input 1 (terminal DE1).

Data	Value	Unit
Encoder protocol	Namur, SCR	-

3.7 Digital outputs

The digital outputs DA2 and DA3 can be configured as low or high frequency pulse or signal outputs.

The digital outputs DA1 and DA4 can exclusively be configured as low frequency pulse or signal outputs.

3.7.1 Nominal data

Data	Value	Unit
Maximum switching voltage	30	V DC
Maximum switching current	100	mA DC
Maximum voltage drop	1	V
Maximum residual current	0.001	mA

3.7.2 LF pulse or signal outputs

Data	Value		Unit
Pulse duration	min.	125	ms
Pause duration	min.	125	ms
Output frequency	max.	4	Hz

3.7.3 HF pulse outputs

The use of outputs as high frequency output is only possible if an external power supply has been connected (see chapter 0).

Only outputs 2 and 3 (terminals DA2 and DA3) can be used as high frequency output.

Data	Value	Unit
Output frequency	max. 1000	Hz



If the HF output is fed via a FE260, the maximum output frequency is limited to 500 Hz (depending on the configuration of the outputs).

3.8 Interfaces

3.8.1 Serial optical interface

Data	Value	Unit
Baud rate	9600	Bd
Format	1 start bit, 1 parity bit, 1 stop bit	

3.8.2 Serial electrical interface

Data	Value
Adjustable types	RS232 or RS485

3.8.2.1 Technical Data of the RS485 Interface

Data	Value
Operating modes	RS485 2-wire (half-duplex) RS485 4-wire (full-duplex)
Termination	Do <u>not</u> use a termination resistor at any device connected
Maximal data transfer rate	19.200 Baud
Number of devices connected to the bus	max. 16 unit loads ¹ Power consumption at the input ² : - 6 unit loads (RS485, not electr. insulated) - 3 unit loads (RS485, electrically insulated)

3.8.3 Integrated modem

Data	Value	Unit
Modem type	2G: GSM / GPRS 3G: GSM / GPRS / UMTS	
Frequency bands	2G: 850 /900 /1800 /1900 3G: 850 /900 /1800 /1900 /2100	MHz

¹ Unit Load: Standard-RS-485 Receiver mit einem Eingangswiderstand = 12kOhm

² Details zum Anschluss der RS485-Schnittstelle s. Applikationshandbuch

3.9 Measurement conditions

3.9.1 Environment

Data	Value	Unit
Temperature range	-25...+55	°C
Relative humidity, max.	93	%

3.10 Labeling

The EK280 is approved as a volume corrector as per the Measuring Instruments Directive (MID). The label is placed on the front panel of the device (see Construction and Function chapter).

3.10.1 Type label of the³ volume corrector

The type label of the EK280 relating to its function as a volume corrector, contains the following information:

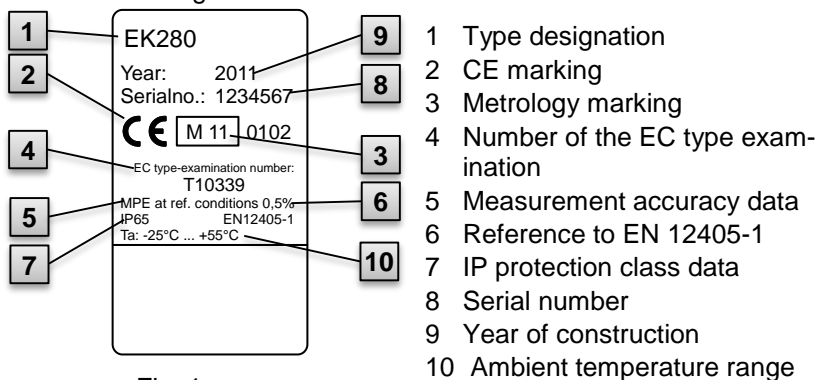

Fig. 1

³ The identification plate may contain other information depending on the design or the country of destination.

3.10.2 ATEX marking

The plate for the "Ex" marking of the EK280 is located on the top panel of the device housing.

3.10.2.1 Zone 1 (without integrated power supply unit)

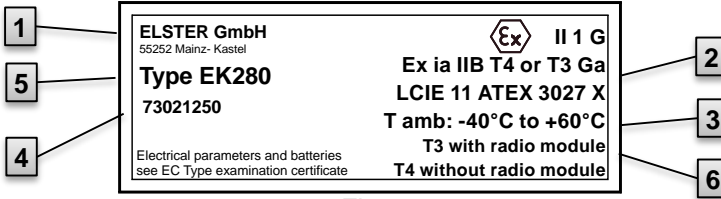

Fig. 2

- 1 Manufacturer and address
- 2 Ex marking
- 3 Permissible ambient temperature range
- 4 Identification number
- 5 Type designation of the device
- 6 Temperature class data

3.10.2.2 Zone 2 (with integrated power supply unit)

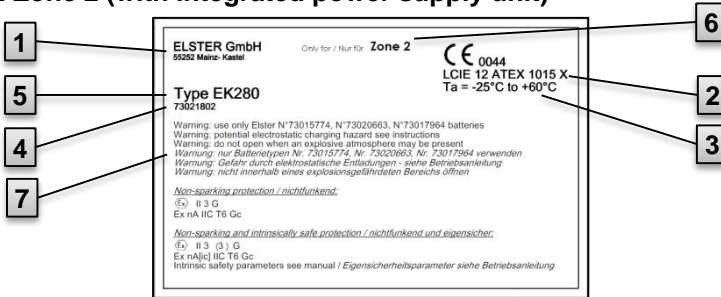

Fig. 3

- 1 Manufacturer and address
- 2 Ex marking
- 3 Permissible ambient temperature range
- 4 Identification number
- 5 Type designation of the device
- 6 Ex zone data
- 7 Warning notices

3.10.3 Device software identification

- Move the cursor using the arrow keys to the "Serv." register and to the values "Vers" (device software version) and "Chk" (checksum) via the following path:
Serv. → Identification → Volume Converter → "Vers" or "Chk"
- The checksum "Chk" can be recalculated for verification purposes by pressing the ENTER button.

4 Construction and Function

4.1 External view

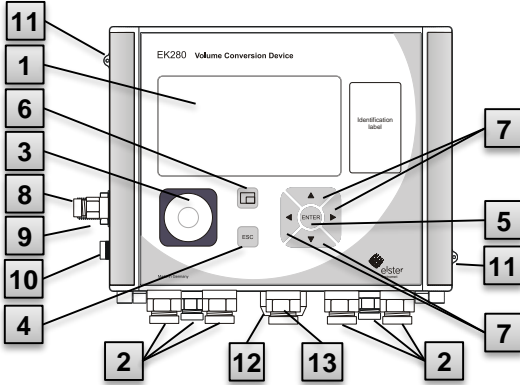



Fig. 4

- 1 Display
- 2 Cable bushings for the connection of additional components
- 3 Optical interface
- 4 Escape button "ESC"
- 5 Enter button "ENTER"
- 6 Function key 
- 7 Arrow keys 
- 8 Pressure sensor
- 9 Cable bushing Temperature sensor
- 10 Earth connection
- 11 Sealing eyelets
- 12 Outdoor plug (optional)
- 13 Cable bushing Aerial

4.2 Internal view

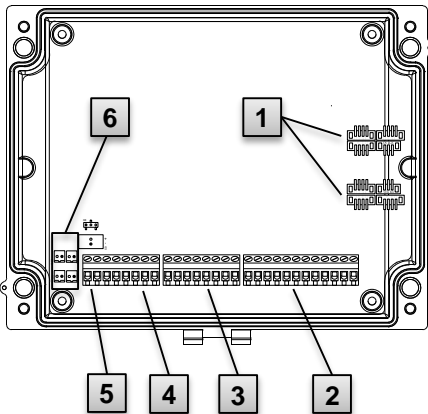

Fig. 5

- 1 Connections for temperature and pressure sensors
- 2 Connections for counting and signal inputs "DE1" to "DE6"
- 3 Connections for pulse and signal outputs "DA1" to "DA4"
- 4 Connections for serial interfaces
- 5 Connections for external power supply "Uext"
- 6 Connections for batteries

4.3 Short description

The volume conversion device EK280 is an explosion-protected electronic device that takes the volume of gas determined by an external meter at measurement conditions to calculate the volume at base conditions and therefore the energy portion of the respective gas volume. Furthermore, the gas flow of a pipeline can be monitored, recorded and transmitted by means of the recording function, the signal inputs and outputs, as well as the serial and optical data interfaces of the device. Recording the necessary state variables for this purpose takes place via an externally or internally connected pressure sensor as well as a temperature sensor. An alphanumeric display and a keyboard on the front panel of the device serve as the control elements for the EK280.

4.4 Connections

The EK280 volume correcter can be connected to:

- Four batteries
- An external power supply

The following can be used to monitor and record the calculated data and to transmit data and program functions:

- Six counting and signal inputs DE1, DE2, DE3, DE4, DE5, DE6
- Four pulse and signal outputs DA1, DA2, DA3, DA4
- Serial data interface
- Optical data interface



Further details on the connection possibilities for the EK280 and the available equipment versions can be found in the "Technical Data" chapter and in chapter "

Assembly, Connection and Putting into Operation".

5 Assembly, Connection and Putting into Operation

5.1 Assembly



DANGER!

Using the wrong model presents a risk of explosion!

The EK280 is available in different models for use in zones 1 and 2.

The model designed for zone 2 should not be used in zone 1 as this presents a risk of explosion!

Therefore:

- Before installing the device in zone 1, please check that the EK280 is suitable for use in zone 1.
- The EK280 should only be operated in zone 1, if category "II 1 G" or "II 2 G" have been marked on the ATEX label.
- If category "II 3 G" has been marked on the ATEX label, the EK280 should not be used in zone 1, but only in zone 2.
- The ATEX label is located on the top panel of the EK280 housing.

The following solely applies for the EK280 model with integrated power supply unit (ATEX category "II 3 G" for use in zone 2):



WARNING!

- Do not open when an explosive atmosphere may be present!
- Electrostatic hazard: Do not rub!



The EK280 can either be mounted on a gas meter, on a pipeline, or on a wall.



Should problems arise during assembly, e.g. with regard to the selection of suitable assembly tools, please contact our customer service team (see "General" chapter).

5.1.1 Assembly on a gas meter



Mount the EK280 on a gas meter using a mounting bracket (see Appendix) as well as the corresponding cylinder screws and square nuts.

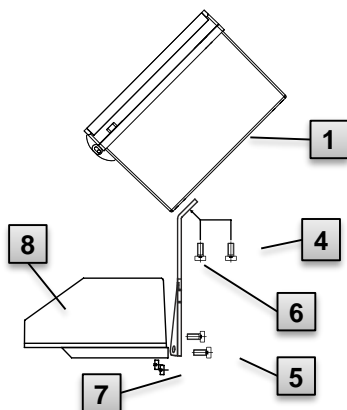

Fig. 6

- Using two M5 x 10 mm (Fig. 6: 4) cylinder screws, attach the mounting bracket (Fig. 6: 6) to the EK280 (Fig. 6: 1).
- Tighten the cylinder screws so that the bracket is sitting in a fixed position.
- Attach the mounting bracket using two square nuts M5 (Fig. 6: 7) and two M5 x 10 mm (Fig. 6: 5) cylinder screws at the back of the meter head (Fig. 6: 8).
- Tighten the cylinder screws so that the device is in a fixed position and cannot fall down.

5.1.2 Assembly on a pipeline



Mount the EK280 to a pipeline using an A2 universal bracket with a pipe clamp (see Appendix) as well as corresponding cylinder screws.

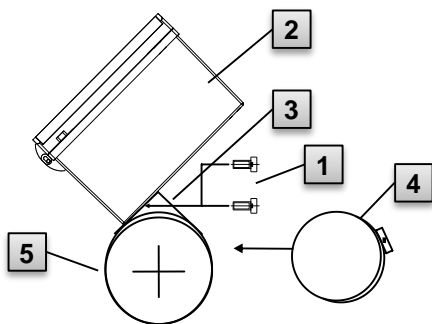

Fig. 7

- Using two M5 x 10 mm (Fig. 7: 1) cylinder screws, insert the A2 universal bracket in the boreholes provided (Fig. 7: 3) on the EK280 (Fig. 7: 2).
 - Tighten the cylinder screws so that the bracket is sitting in a fixed position.
 - The A2 universal bracket (Fig. 7: 3) and the device (Fig. 7: 2) should be fastened to the pipeline (Fig. 7: 5) using the pipe clamp (Fig. 7: 4)
4. The device should be mounted on the pipeline in such a way that it is in a fixed position and cannot fall down.

5.1.3 Assembly on a wall

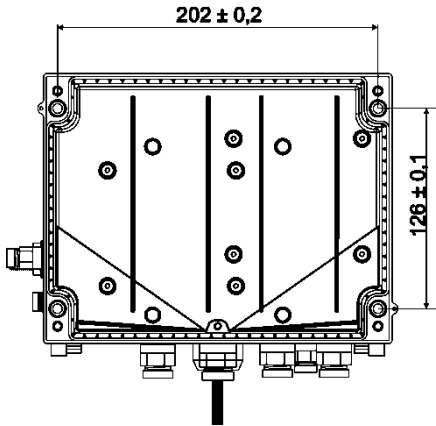

Fig. 8

1. Bore four holes in the positions marked on the wall (see dimensions in Fig. 8).
2. Select wall plugs which correspond to the size of the screws and insert these in the boreholes in the wall.
3. To fasten the EK280, four M5 x 40 mm wood screws should be used for wall assembly.

5.1.4 Three-way valve

When mounting the pressure sensor, a three-way valve is usually incorporated in order to test the pressure sensor in an installed condition or to exchange a faulty sensor without switching off the entire gas pipeline. The three-way valve available from Elster is constructed as follows:

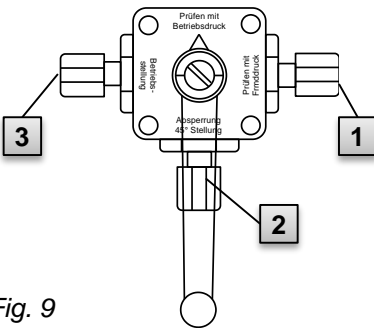

Fig. 9

- 1** : From the meter: From the pressure connection of the gas meter. For diaphragm gas meters, this takes place on the input side of the meter.
- 2** : To the VC: For the connection of the pressure sensor to the volume corrector.
- 3** : Test connection: Possible to take the test pressure or to assert external pressure on the pressure sensor of the volume corrector.



When mounting the three-way valve, it must be ensured that the position of the control lever with the corresponding outlets is checked as the lever can be removed and may be mounted the wrong way round.



The pipeline from the pressure sensor to the meter must be laid at an angle in order to ensure that water does not damage the pressure sensor or affect the measurement accuracy.

5.2 Connection



The EK280 is available as both a calibrated and non-calibrated device. Information regarding additional equipment versions of the EK280 can be found under www.elster-instromet.com.



DANGER!

The connection of non intrinsically-safe or non-associated equipment presents a risk of explosion!

The operation of the EK280 in zones 1 and 2 and the connection of non intrinsically-safe equipment which exceeds those conditions and limit values specified in the declaration of conformity, presents a risk of explosion.

Therefore:

- The device should only be connected inside zones 1 and 2 and only to certified associated equipment as per the ATEX Product Directive 94/9/EC.
- Only devices with intrinsically-safe circuits and electrical data that corresponds to those requirements stipulated in the declaration of conformity for the EK280 (see Appendix), should be connected.



WARNING!

Risk caused by incorrect connection of the device!

The device should solely be connected by a gas specialist (see "Safety" chapter). Incorrect connections may lead to life-threatening situations or significant material damage.

Therefore:

- The calibrated device should only be connected by a gas specialist.
- The same specialist should also be consulted if subsequent changes to location arise.
- Please refrain from unauthorized connections and relocations of the device.

- When connecting the EK280 and putting it into operation, the guidelines of the corresponding DIN EN 60079-0 and DIN EN 60079-14 standards should be observed.
- The wiring of the connections should be professionally carried out by a gas specialist or a calibration officer.
- Active outputs cannot be switched.

- Connect unused cable glands as per DIN EN 60079-14 with the help of a plug or a suitable screw cap.

In order to program the device and perform further applications, and in addition to the components specified in this chapter, you can also connect an external power supply to the other connections as well as the serial and optical interface of the EK280 (see "Construction and Function" chapter). Further details can be found under www.elster-instromet.com.



The connections described below should only be sealed by a calibration officer. If the EK280 is used for operations which are not subject to calibration regulations, the seals on the respective connections can be omitted.

5.2.1 Connecting the gas meter

In order to measure the gas volume, a gas meter with a low or high frequency pulse transducer or encoder can be connected to the digital input "DE1" of the EK280.

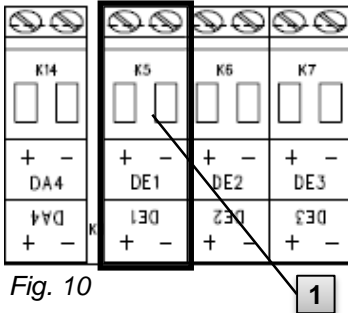

The pulse transducer or encoder of the gas meter will be connected to the "DE1" terminal (**1**) of the EK280. Further details and special features regarding the use of the pulse transducer and encoder are described in the following sub-chapters.



The cable core diameter for the connection to the EK280 inputs is 0.33 ... 2.5 mm².

5.2.1.1 Connection to a low frequency pulse transducer

1. Connect the pulse output of the gas meter to the "DE1" terminal (**1** in Fig. 10, page 36) of the EK280.
The polarity can be freely selected (the symbols "+" and "-" on the terminals are used for the connection of other pulse transducers or encoders).
2. Adjust the measurement parameters, e.g. the cp value (pulse constant), as described in chapter 5.3.1.3 .

5.2.1.2 Connection to an encoder

1. Connect the encoder of the gas meter to the "DE1" terminal (1 in Fig. 10, page 36) of the EK280.
The polarity should be taken into consideration, i.e. connect the "+" of the encoder to the "DE1 +" terminal and "-" to the "DE1 -" terminal respectively.
2. Adjust the measurement parameters, e.g. the encoder type, as described in chapter 5.3.1.3.

5.2.1.3 Connection to a high frequency pulse transducer



The EK280 can only count the pulses of a high frequency pulse transducer if there is an external power supply - not when in battery mode.

In order to ensure an uninterrupted measurement of the gas volume, the EK280 can be configured in such a way that the device automatically switches to a low frequency pulse transducer in the event of a failure of the external power supply; see chapter 5.2.1.4.



If you would like to use the automatic switching function of the pulse transducer, please proceed as per chapter 5.2.1.4!

1. Connect the high frequency pulse output of the gas meter to the "DE1" terminal (1 in Fig. 10, page 36) of the EK280.
The polarity should be taken into consideration, i.e. connect the "+" of the pulse transducer with the "DE1 +" terminal and "-" with the "DE1 -" terminal respectively.
2. Adjust the measurement parameters, e.g. the cp value (pulse constant), as described in chapter 5.3.1.2.

5.2.1.4 Automatic switchover of the pulse transducer

The EK280 should be configured as described in order to ensure an uninterrupted measurement of the gas volume when using a high frequency pulse transducer.

If the power supply is in a functioning order, the volumes and flows (V_b , V_m , Q_b , Q_m) will be measured with the high frequency pulse transducer. In the event of a failure of the external power supply, the EK280 will automatically switch to the low frequency pulse transducer.

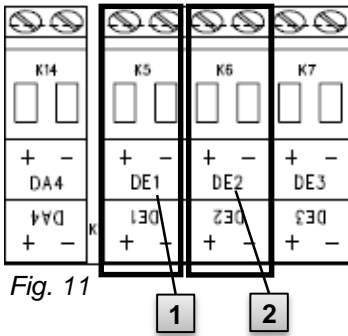

Fig. 11

1. Connect the low frequency pulse transducer of the gas meter to the "DE1" terminal (1) of the EK280.
2. Connect the high frequency pulse transducer of the gas meter to the "DE2" terminal (2) of the EK280.

Adjust the measurement parameters, e.g. the cp value (pulse constant), as described in chapter 0.

5.2.2 Sealing the input terminals

After connecting to the gas meter as per chapter 5.2.1, the input terminal "DE1" must be sealed for official calibration measurements.

For this purpose, terminal covers are provided in the bag of accessories. If required, these should be screwed over the connected terminals and an adhesive seal should then be bonded to the fastening screw (see chapter 5.3.2).

5.2.3 Connecting the temperature sensor



Any national requirements must be observed when connecting the temperature sensor.

The requirements of the PTB Testing Instructions, Volume 20, Electronic volume conversion device for gas, Chapter 5, shall apply to Germany.



Before connecting, the temperature sensor should be lubricated with heat transfer fluid in order to enhance its functionality.

5.2.3.1 Connection to a standard temperature sensor pocket

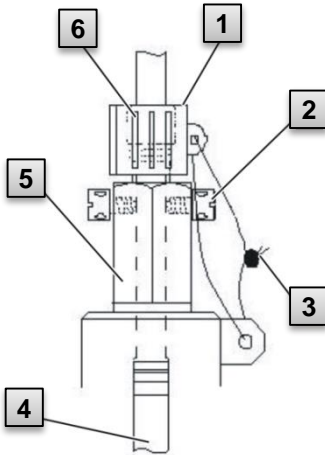

Fig. 12

Insert the temperature sensor Pt500 **4** into the temperature sensor pocket **5** (see Appendix). Fasten the temperature sensor using the capstan screw **2** and screw connections provided **6**. Have a calibration officer seal the temperature sensor using the sealing sleeve **1** and the wire seal **3** as per Fig. 12.

5.2.3.2 Connection to an older temperature sensor pocket

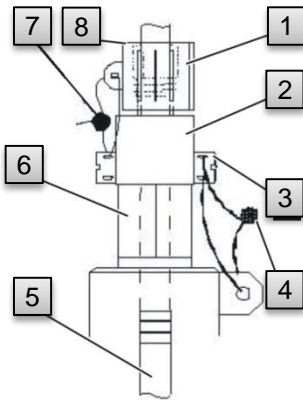

Fig. 13

1. Insert the temperature sensor Pt500 **5** into the temperature sensor pocket **6** (see Appendix).
2. Use the adapter **2** to seal the connection (see Appendix).
3. Fasten the temperature sensor using the capstan screw **3** and the screw connections **8** provided.
4. Have a calibration officer seal the temperature sensor using the sealing sleeve **1** and the wire seal **4**, **7**.

5.2.4 Connecting the pressure pipe



Any national requirements must be observed when connecting the pressure pipes. The requirements of the PTB Testing Instructions, Volume 20, Electronic volume conversion device for gas, Chapter 5, shall apply to Germany.



Efforts must be made to ensure the pipes are installed downwards.

5.2.4.1 Connection to an internal pressure sensor

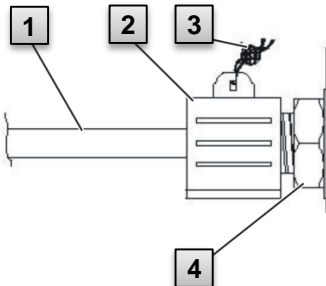

Fig. 14

1. Connect the pressure connection to the internal pressure sensor connection **1** using the union nut and the sealing insert **4**.
2. Have a calibration officer seal the connection with the sealing sleeve **2** and a wire seal **3**.

5.2.4.2 Connection to an external pressure sensor

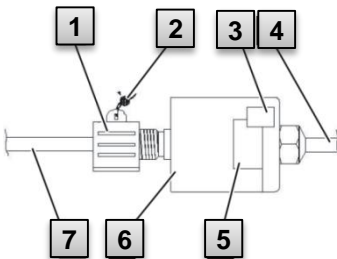

Fig. 15

1. Connect the pressure connection **7** to the external pressure sensor **6**.
2. Have a calibration officer seal the connection with a sealing sleeve **1**.

5.2.5 Connecting the power supply

5.2.5.1 Power supply for the EK280 without integrated power supply unit



DANGER!

The connection of non-associated equipment presents a risk of explosion!

Operating the EK280 in zone 1 and connecting devices which are not certified as "associated equipment" present a risk of explosion.

Therefore:

- When using the EK280 in zone 1, it should only be connected to certified associated equipment as per the ATEX Product Directive 94/9/EC.
- The EK280 should only be connected to the intrinsically-safe circuits of associated equipment whose electrical data corresponds to those requirements stipulated in the declaration of conformity for the EK280 (see Appendix).

For the external power supply of the EK280 (model without in-built power supply unit), the electrical data should be adhered to as per chapters 9.3 and 3.2.3.

The extended function unit "FE260" from Elster can also be used as a power supply unit, for example.

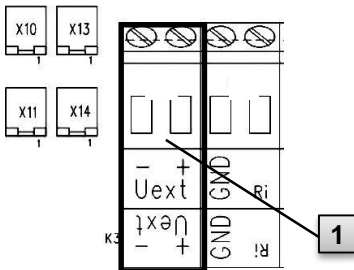

Connect the power supply to the "Uext" terminal (**1**) of the EK280.

The polarity should be taken into consideration, i.e. connect the "+" of the power supply unit to the "Uext +" terminal and "-" to "Uext".

Fig. 16

5.2.5.2 Power supply for the EK280 with integrated power supply unit



DANGER!
Danger to life from electrical current!

Touching live parts poses an imminent danger to life.
 Therefore:

- Works on the electrical components of the device, i.e. the connection of the power supply unit, should solely be carried out by qualified electricians.
- When performing all works to the electrical system, switch off the power, secure it against an accidental re-start and check to ensure that the voltage has been cut.
- Keep live parts away from moisture. This could lead to a short-circuit.

The power supply unit to connect the 230 V~ power supply, is in-built into the base of the EK280.

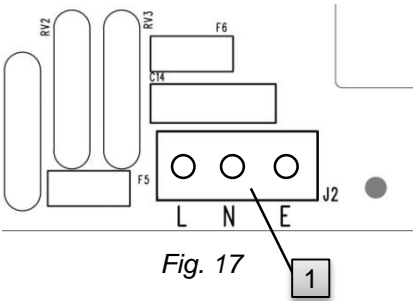

Fig. 17

1. Switch off the supply voltage and secure it against an accidental re-start!
2. Connect the 230 V~ supply voltage to the "J2" terminal block (1) of the EK280.
 Terminal "E" is the connection for the protective conductor (protective earthing).



The cable core diameter for the connection to the integrated power supply unit is 0.2 ... 1.5 mm².



DANGER!
Danger to life from electrical current!

Connect protective ground wire of mains-supply to screw terminal J2, connection E!

5.2.6 Connect outputs of the EK280



The cable core diameter for the connection to the EK280 outputs is 0.33 ... 2.5 mm².



Different downstream devices can be connected to the digital outputs of the EK280. The outputs are preconfigured for this purpose (see chapter 5.3.1.13).

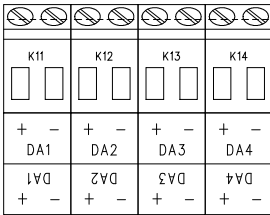

Fig. 18

1. Connect the downstream device to the corresponding digital outputs (terminals "DA1" to "DA4") of the EK280 (p. Fig. 18).
2. Terminal covers are provided in the bag of accessories to seal the output terminals. If required, these should be screwed over the connected terminals and a seal should then be bonded to the fastening screw (see chapter 5.3.2).
3. If necessary, adjust the cp value (pulse contact) for the pulse outputs as described in chapter 5.3.1.13.

5.2.6.1 Electrical insulation of the outputs

In standard cases, all negative poles of the outputs are electrically connected to the motherboard.

For special applications, i.e. switching a positive pole, each output can be electrically separated from the motherboard and from the other outputs.



CAUTION!

Reduced battery life

Activating the electrical insulation of outputs reduces the battery life when in battery mode!

It is then impossible to give a reliable prediction of the remaining battery life.



An electrically-insulated output only requires electricity if the output is active (switched-on). You can therefore minimize the negative influence of an electrically-insulated output on the battery life by setting the pulse duration to the lowest possible value when using it as a pulse output.

The configuration software "enSuite" can be used for this purpose.



The electrical insulation of the outputs is not an approved electrical isolation in accordance with ATEX. An approved Ex-isolator is required when using the device in Ex zone 1.

In order to activate the electrical insulation of an output, please move the switch lever behind the corresponding output terminal away from the terminal:

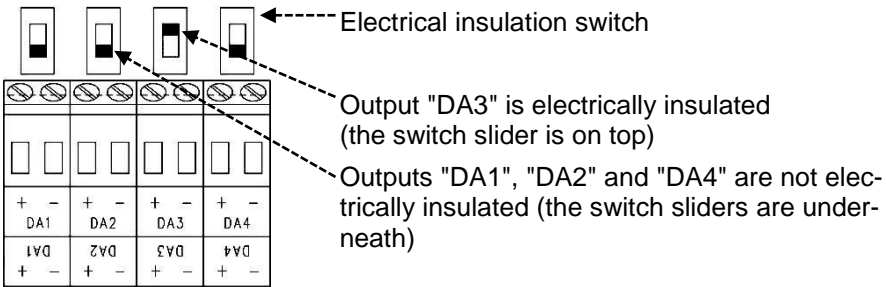

Fig. 19

5.2.7 Earthing the EK280 housing



The housing of the EK280 must always be earthed. A M6 screw is provided for this on the left-hand side of the housing.

1. The earth-cable must have a minimum diameter of 4mm².
2. Use the cable to connect the screw on the left-hand side of the housing with the equipotential bonding strip.

5.2.8 Earthing the cable connections of the EK280



All cables firmly connected to the EK280 have a shield. This is connected to the cable glands of the EK280 in order to prevent electromagnetic interference.



Only shielded cables should be used for new connections. The cable shield should be completely earthed on both sides. For this purpose, the EK280 is equipped with special cable glands.

5.2.9 Additional measures for installation in zone 2



For the installation of the EK280 model with an integrated power supply unit (ATEX category "II 3 G") in zone 2, the following additional measures are necessary:

- A cable-tie must be mounted on each cable inside the housing as strain relief.
Place the cable-tie right beside the cable gland.
- All cable glands have to be fastened with minimum
 - 6 Nm for metal glands
 - 1.5 Nm for plastic glands
- Use only cables with the following outside-diameters for installation of the different cable gland types

M12, metal:	4.5 mm
M16 and M20, metal:	8 mm
M16, plastic:	8 mm

The ATEX category "II 1 G" models of the EK280 (without in-built power supply unit) should be installed in both zones 1 and 2 without these additional measures.

5.3 Putting into operation

5.3.1 Configuration of measurement parameters



If the EK280 is subject to calibration regulations, the works described below should only be performed by legally authorized individuals.

The necessary measurement parameters can be adjusted using the free configuration program "enSuite" , which is available under www.elster-instromet.com.

If the program is not available, the configuration can also be carried out using the keyboard as described below.



Before adjusting the measurement parameters via the keyboard, please read chapter 6 to learn how the device is operated.

5.3.1.1 Opening the calibration lock

The calibration lock is located at the back of the housing cover in the form of a button, and this can be secured by means of an adhesive label. This button must be pressed in order to adjust the values and parameters protected by configuration regulations.

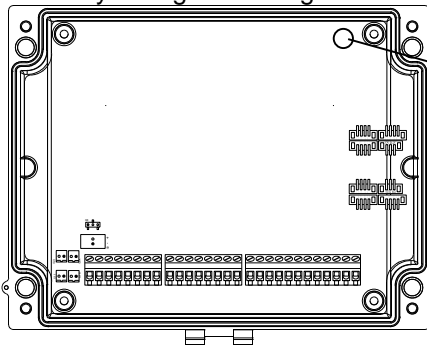

Position of the button to open the calibration lock.

5.3.1.2 Adjusting the parameters for the low frequency pulse transducer of the gas meter

If a low frequency pulse transducer is connected as per 0, adjust the input mode and the cp value as follows:

1. Adjusting the input mode:
 - Move the cursor to the "Serv." register and to the input mode "Md.I1" via the following path:
Serv. → Inputs → Input 1 → Md.I1
 - Press the ENTER button ⇒ The set value will start to flash.
 - Press one of the arrow keys ▲ or ▼ until the text "Pulse input" starts to flash.
 - Press the ENTER button to confirm the set value. The input value can be deleted by pressing the ESC button.
2. Adjusting the cp value (pulse constant):
 - Move the cursor to the cp value "cp.I1" via the same path.
 - Press the ENTER button ⇒ The value will start to flash.
 - Move the cursor using the arrow keys ► or ◀ to the digits and change these using the arrow keys ▲ or ▼.
 - Press the ENTER button to confirm the set value. The input value can be deleted by pressing the ESC button.

5.3.1.3 Activating encoder mode

If an encoder is connected as per 5.2.1.2, the encoder mode is activated as follows:

Start the "Auto Detect" function using the keyboard of the EK280 as follows:

- Move the cursor to the "Serv." register and to the value "Md.I1" (input mode) via the following path:
Serv. → Inputs → Input 1 → Md.I1
- Press the ENTER button ⇒ The set value will start to flash.
- Press one of the arrow keys ▲ or ▼ until the text "Auto-Encoder" starts to flash.
- Press the ENTER button to confirm the set value. The input value can be deleted by pressing the ESC button.
- Wait until "Auto-Encoder" is replaced by another value. This may take up to one minute as the EK280 consecutively activates and tests all known encoder protocols.
- Once the EK280 has successfully detected the encoder, it will display the meter reading of the gas meter with the description "Vo":
Serv. → Volume → Inputs → Input 1 → Vo

Unlike the "Auto Detect" function, you can also select the connected encoder type directly under "Md.I1".

Serv. → Volume → Inputs → Input 1 → Md.I1

The following encoder types can be selected:

Md.I1	Meaning
Enc.Namur a	Encoder Namur a protocol
Enc.SCR EDIS	Encoder SCR EDIS95
Enc.SCR OBIS	Encoder SCR OBIS05
Enc.Nam. a-b	Encoder Namur a and b protocol

5.3.1.4 Adjusting the parameters for the high frequency pulse transducer of the gas meter

If a high frequency pulse transducer is connected as per 5.2.1.3, the input mode and the cp value should be adjusted as follows:

1. Adjusting the input mode:

- Move the cursor to the "Serv." register and to the input mode "Md.I1" via the following path:

Serv. → Inputs → Input 1 → Md.i1

- Press the ENTER button ⇒ The set value will start to flash.
- Press one of the arrow keys ▲ or ▼ until the text "HF pulses" starts to flash.
- Press the ENTER button to confirm the set value. The input value can be deleted by pressing the ESC button.

2. Adjusting the cp value (pulse constant):

- Move the cursor to the cp value "cp.I1" via the same path.
- Press the ENTER button ⇒ The value will start to flash.
- Move the cursor using the arrow keys ► or ◀ to the digits and change these using the arrow keys ▲ or ▼.
- Press the ENTER button to confirm the set value. The input value can be deleted by pressing the ESC button.

5.3.1.5 Adjusting the automatic switchover of the pulse transducer

If the automatic switchover of the pulse transducer (see chapter 5.2.1.4) is used, adjust the necessary parameters as follows:

1. Adjusting the automatic switchover:

- Move the cursor to the "Serv." register and to the value "Sc.Vm" (sources for the volume at measurement conditions) via the following path:

Serv. → Volume → Actual volume → Parameter settings → Sc.Vm

- Press the ENTER button ⇒ The set value will start to flash.
 - Press one of the arrow keys ▲ or ▼ until the text "Input 2" starts to flash.
 - Press the ENTER button to confirm the set value. The input value can be deleted by pressing the ESC button.
2. Adjust the input mode of the high frequency pulse transducer:
- Press the button ▼ to display "Md.I2".
 - Press the ENTER button ⇒ The set value will start to flash.
 - Press one of the arrow keys ▲ or ▼ until the text "HF pulses" starts to flash.
 - Press the ENTER button to confirm the set value. The input value can be deleted by pressing the ESC button.
3. Adjust the cp value of the high frequency pulse transducer:
- Press the button ▼ to display "cp.I2".
 - Press the ENTER button ⇒ The set value will start to flash.
 - Move the cursor using the arrow keys ► or ◀ to the digits and change these using the arrow keys ▲ or ▼ to the cp value of the pulse transducer connected to input 2.
 - Press the ENTER button to confirm the set value. The input value can be deleted by pressing the ESC button.
4. Adjust the parameters for the low frequency pulse transducer:
- Adjust the parameters for the low frequency pulse transducer on input 1 as described in chapter 5.3.1.2.

5.3.1.6 Setting the volume at measurement conditions

In order to control the recording of the volume at measurement conditions, the EK280 meter can be set once to the same value as the gas meter if the administrator lock is open. It is always possible to set the volume if the calibration lock is open:

- Open the administrator lock or the calibration lock
- Move the cursor to the „Serv.“ tab and go to the value „VmA“ (adjustable volume at measurement conditions) via the following path:
Serv. → Volume → Actual volume → Synchronization Vm → VmA
- Press the ENTER key ⇒ One of the value digits flashes.
- Move the cursor using the arrow keys ► or ◀ to the digits and change these using the arrow keys ▲ or ▼.
- Once you have changed all of the digits, press the ENTER key in order to confirm your entry. The entry can be cancelled by pressing the ESC key.
- In order to accept the set value, move the cursor to the value „Store“
- Press the ENTER key ⇒ „0“ flashes.

- Change the value using the arrow keys ▲ or ▼ to „1“
- Once you have changed the value, press the ENTER key in order to confirm your entry. The entry can be cancelled by pressing the ESC key. ⇒ „Vm“ is assumed for „VmA“.



If, when the administrator lock is open, the assumption of „VmA“ for „Vm“ is rejected with the message –13--, then this process has already been carried out once.

Other changes are possible if the calibration lock is open or, if the administrator lock is open, after deleting the change information for comparison of „Vm“ with the gas meter (see chapter 5.3.1.7).

5.3.1.7 Deleting change information for comparison of Vm with the gas meter

In order to allow the volume at measurement conditions to be reset if the administrator lock is open, the change information for comparison of "Vm" with the gas meter must be deleted:

- Open the calibration lock
- Move the cursor to the „Serv.“ tab and go to the value „Clea“ (deleting change information) via the following path:
 Serv. → Volume → Actual volume → Synchronization Vm → Clear
- Press the ENTER key ⇒ „0“ flashes.
- Change the value using the arrow keys ▲ or ▼ to „1“
- Once you have changed the value, press the ENTER key in order to confirm your entry. The entry can be cancelled by pressing the ESC key. ⇒ „TimeX“ (time stamp of comparison), „Vm_o“ (Vm old value), „Vm_n“ (Vm new value) are set to default value.

5.3.1.8 Setting the volume at base conditions

For the EK280 volume conversion device, there is the option available when commissioning the device to set the volume at base conditions meter once if the administrator lock is open. It is always possible to set the volume if the calibration lock is open:

- Open the administrator lock or the calibration lock
- Move the cursor to the „Serv.“ tab and go to the value „VbA“ (adjustable volume at base conditions meter) via the following path:
 Serv. → Volume → Standard volume → Synchronization Vb → VbA
- Press the ENTER key ⇒ One of the value digits flashes.
- Move the cursor using the arrow keys ► or ◀ to the digits and change these using the arrow keys ▲ or ▼.

- Once you have changed all of the digits, press the ENTER key in order to confirm your entry. The entry can be cancelled by pressing the ESC key.
- In order to accept the set value, move the cursor to the value „Store“
- Press the ENTER key ⇒ „0“ flashes.
- Change the value using the arrow keys ▲ or ▼ to „1“
- Once you have changed the value, press the ENTER key in order to confirm your entry. The entry can be cancelled by pressing the ESC key. ⇒ „Vb“ is assumed for „VbA“.



If, when the administrator lock is open, the assumption of „VbA“ for „Vb“ is rejected with the message –13--, then this process has already been carried out once.

Other changes are possible if the calibration lock is open or, if the administrator lock is open, after deleting the change information for comparison of „Vb“ (see chapter 5.3.1.9).

5.3.1.9 Deleting change information for comparison of Vb with the gas meter

In order to allow the volume at base conditions to be reset if the administrator lock is open, the change information for comparison of „Vb“ must be deleted:

- Open the calibration lock
- Move the cursor to the „Serv.“ tab and go to the value „Clear“ (deleting change information) via the following path:
 Serv. → Volume → Standard volume → Synchronization Vb → Clear
- Press the ENTER key ⇒ „0“ flashes.
- Change the value using the arrow keys ▲ or ▼ to „1“
- Once you have changed the value, press the ENTER key in order to confirm your entry. The entry can be cancelled by pressing the ESC key. ⇒ „TimeX“ (time stamp of comparison), „Vb_o“ (Vb old value), „Vb_n“ (Vb new value) are set to default values.

5.3.1.10 Adjust compressibility equation and gas analysis

- Move the cursor to the "Serv." register and to the value "Md.K" (compressibility equation) via the following path:
 Serv. → Volume conversion → Parameter settings → Md.K
- Press the ENTER button ⇒ The set value will start to flash.
- Change the value using the arrow keys ▲ or ▼. Adhere to the valid legal provisions for the area of application.

Md.K	Meaning
fix value	No calculation of compressibility. The adjustable value "K.F" will be used.
S-Gerg-88	Calculation of compressibility as per S-Gerg-88
AGA- NX19	Calculation of compressibility as per AGA-NX19
AGA-8 GC1	AGA8 Gross Characterization Method 1
AGA-8 GC2	AGA8 Gross Characterization Method 2
AGA-NX19-HW	AGA-NX19 according to Herning and Wolowsky
AGA-8 DC92	Calculation of compressibility as per AGA8 DC92

- Press the ENTER button to confirm the set value. The input value can be deleted by pressing the ESC button.
- Move the cursor along to the gas analysis values (Ho.b, CO₂, etc.) using the arrow keys ▲ or ▼.
- Change the values according to the gas used by confirming the input by pressing the ENTER button, or use the arrow keys ► or ◀ to go to the digits and change these with the buttons ▲ or ▼.
- Press the ENTER button to confirm the set value. The input value can be deleted by pressing the ESC button.

5.3.1.11 Adjust alarm limits for gas pressure and temperature measurement

Alarm limits are set to default values ex-factory. If a change becomes necessary, please proceed as follows:

- Move the cursor to the "Serv." register and move to the alarm limit values via the following paths:
Serv. → Measured values → Pressure → Parameter settings → pMin and pMax
Serv. → Measured values → Temperature → Parameter settings → TMin and TMax
- Press the ENTER button to confirm the input.
- Use the arrow keys ► or ◀ to go to the digits and change these with the arrow keys ▲ or ▼.
- Press the ENTER button to confirm the set value. The input value can be deleted by pressing the ESC button.

5.3.1.12 Adjusting replacement values for gas pressure and gas temperature

If the gas pressure or gas temperature cannot be measured due to a fault, an adjustable replacement value (fixed value) will be used to calculate the

volume at base conditions. The volume calculated in this way will be counted in the separate disturbance quantity meter "VbD".

The replacement values can be found under the following paths:

Serv. → Measured values → Pressure → Parameter settings → p.F

Serv. → Measured values → Temperature → Parameter settings → T.F

Changing the values generally takes place precisely as described in chapter 5.3.1.11 for the alarm limit values.

5.3.1.13 Configuration of the outputs



The cp values (pulse constants) for the outputs can also be configured using the enSuite software.

The following functions are preset ex-factory for the outputs:

Outputs	Function
Output 1	Pulse output for the total volume at base conditions "VbT" (cp.O1= 0.1)
Output 2	Pulse output for the total volume at measurement conditions "VmT" (cp.O2= 0.1)
Output 3	Status output for warnings (see chapter 8.2)
Output 4	Status output for alarms (see chapter 8.2)

The cp value of an output indicates how many pulses are emitted per cubic meter. A cp value of 0.1 / m³ (0.1 pulses per m³) means, for example, that one pulse is emitted per 10 m³.

To change the cp values for output 1 or output 2, move the cursor to the "Serv." register and go to "cp.O1" (for output 1) or "cp.O2" (for output 2) via the following path:

Serv. → Outputs → Output 1 → cp.O1

or *Serv.* → Outputs → Output 2 → cp.O2

- Press the ENTER button ⇒ The cp value will flash.
- Move the cursor using the arrow keys ► or ◀ to the digits and change these using the arrow keys ▲ or ▼.
- Press the ENTER button to confirm the set value. The input value can be deleted by pressing the ESC button.



Aside from the settings described here, a range of other functions can be configured for the outputs, e.g. high frequency or time-synchronous pulses.

A complete description can be found in the EK280 Application Manual that can be downloaded under www.elster-instromet.com.

5.3.1.14 Setting the daylight saving time

- Move the cursor to the "Serv." register and to the "MdTim" value (daylight saving mode) via the following path:
Serv. → Date and Time → MdTim
- Press the ENTER button ⇒ The set value will start to flash.
- Change the value using the arrow keys ▲ or ▼:

MdTim	Meaning
CEST off	No switchover to daylight saving time
CEST autom.	Automatic switchover to daylight saving time (CEST = Central European Summer Time)
CEST manual	The start and end of daylight saving time is configured by the control center every year.

- Press the ENTER button to confirm the set value. The input value can be deleted by pressing the ESC button.

5.3.1.15 Deleting the measurement archive



Deleting the archive is not absolutely necessary when putting the device into operation.

- Move the cursor to the "Serv." register and to the "Clr.A" value (delete measurement archive) via the following path:
Serv. → Edit and delete → Clr.A



*All measurement archives (no logs) will be deleted.
 In order to ensure that the archive is not accidentally deleted, the serial number of the EK280 must be entered whilst the calibration lock is open (the number is located on EK280 identification plate).*

- Press the ENTER button ⇒ The value will start to flash.
- Move the cursor using the arrow keys ► or ◀ to the digits and enter the serial number of the device using the arrow keys ▲ or ▼.
- After you have entered the serial number of the device, press the ENTER button to confirm the input. The input value can be deleted by pressing the ESC button.

5.3.1.16 Deleting the certification data log

 *The log can only be deleted if the calibration lock is open.*

- Move the cursor to the "Serv." register and to the value "CICDL" (delete certification data log) via the following path:
Serv. → Change and Delete → CICDL
- Press the ENTER button ⇒ "0" will start to flash.
- Change the value to "1" with the arrow keys ▲ or ▼.
- After you have entered the value, press the ENTER button to confirm the input. The input value can be deleted by pressing the ESC button.

5.3.1.17 Closing and securing the calibration lock

After all settings subject to calibration regulations have been adjusted, close the calibration lock in the same way that it was opened: Press the buttons described in chapter 5.3.1.1 once again. The calibration switch is secured with an adhesive label as described in chapter 0.

5.3.1.18 Programing a data transfer

To discover the wide range of possibilities for remote data transfer to a control center via the integrated modem or via a device connected to the terminal interface, please follow the corresponding instructions in the EK280 Application Manual, which you can download from www.elster-instromet.com.

The data transfer settings can be configured without opening the calibration lock.

5.3.2 Sealing

5.3.2.1 External view

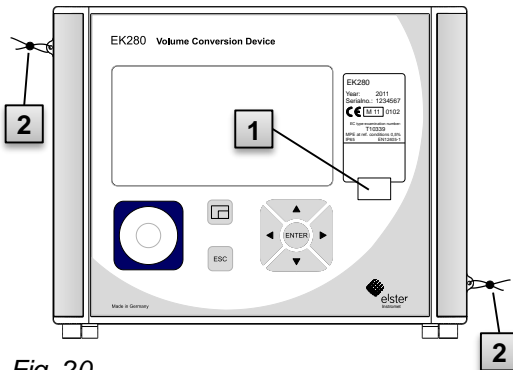

- 1 Possible sealing point to secure the identification plate via adhesive seal.
- 2 Optional user lock: Seal covers using wire seals through sealing eyelets.

Fig. 20

5.3.2.2 Internal view

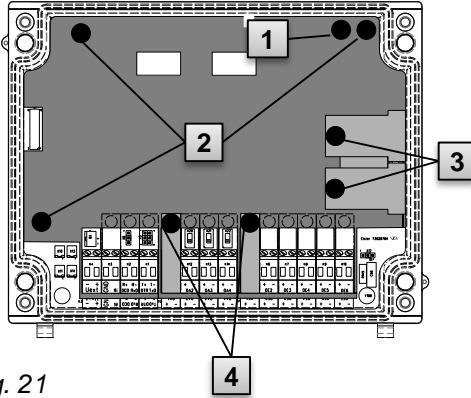

- 1 Sealing point to secure the calibration switch.
- 2 Sealing points to secure the circuit board cover
- 3 Sealing points to secure the sensor covers for the pressure and temperature sensors.
- 4 Sealing points to secure the terminal covers of the inputs, outputs and interfaces if necessary.

Fig. 21



These sealing points

Fig. 21/4 to secure the pulse inputs and pulse outputs are subject to national regulations (cf. WELMEC 11.1, chapter 2.7.1).

Depending on the legal situation in the respective country of use, seals produced by legally authorized manufacturers or the metering point operators, should be used.

If the devices are supplied with connected input and/or output cables, seals will be provided with the manufacturing symbol as standard. If necessary, these can be replaced in the area of application as described above.

5.3.2.3 Sensors



Examples of how to seal the connected temperature and pressure sensors are presented in chapters 5.2.3 and 5.2.4.

5.3.3 Closing the housing



CAUTION!

Material damage may arise through improper closing of the device!

Improper closing of the device may lead to material damage as a result of cable connections being squashed.

Therefore:

- Please ensure that the cable ducts are positioned correctly when closing the device.
- To close, slightly raise the lid on its hinges.

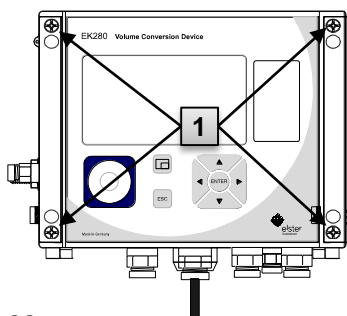

Fig. 22

1. Close the housing using the four screws provided (Fig. 22/1).
2. Close the unused cable glands using the sealing plugs provided within the scope of supply.

5.3.4 Verifying assembly and connection



WARNING!

Risk as a result of incorrect assembly and connection

Incorrect assembly and connection of the EK280 may lead to life-threatening situations.

Therefore:

- Assemble and connect the EK280 correctly.
- Sealing should solely be carried out by a calibration officer.
- Follow the guidelines of DIN EN 60079-14, DIN EN 60079-0, the ATEX Product Directive 94/9/EC as well as the ATEX Operating Directive 1999/92/EC EN.

6 Operation



The "enSuite" software and data interfaces of the EK280 can be used to perform further applications other than those described below. Instructions can be found under www.elster-instromet.com.

6.1 Safety

6.1.1 Personal protective equipment

When working on the device inside a gas-handling plant, personal protective equipment must be worn to minimize risks to health.

- During works on the device, the necessary personal protective equipment must be worn inside the respective plant at all times
- The notices relating to personal protective equipment mounted in the working area must be followed at all times.

6.2 Operating personnel

The following groups of people are authorized to perform different functions when operating the EK280.

6.2.1 Instructed personnel

A person instructed on how to operate the EK280, who

- will be informed of the tasks assigned to them and possible risks resulting from inappropriate behavior, in a training session provided by the operator.
- is authorized to read and take note of values and parameters using the control elements of the EK280.

6.2.2 Qualified personnel

A person qualified to operate the EK280, who,

- on the basis of their specialist training, knowledge and experience, as well as their awareness of the relevant statutory provisions, are in a position to perform their assigned tasks on the device and are able to independently identify and prevent possible risks.
- are authorized to read and take note of values and parameters using the control elements of the EK280, and to perform changes which are not subject to calibration regulations.

6.2.3 Calibration officers

A calibration officer, who,

- on the basis of their professional training, knowledge and experience and awareness of applicable standards and regulations, are in a position to perform the works on gas systems. The calibration officer will be trained on works on devices and installations subject to calibration regulations and will be familiar with the relevant standards and regulations.
- is authorized to read and take note of values and parameters using the control elements of the EK280, and to perform changes which are not subject to calibration regulations.

6.3 Basic principles

As already explained in the "Construction and Function" chapter, the EK280 can be operated and programmed using the control elements on the front panel of the device.

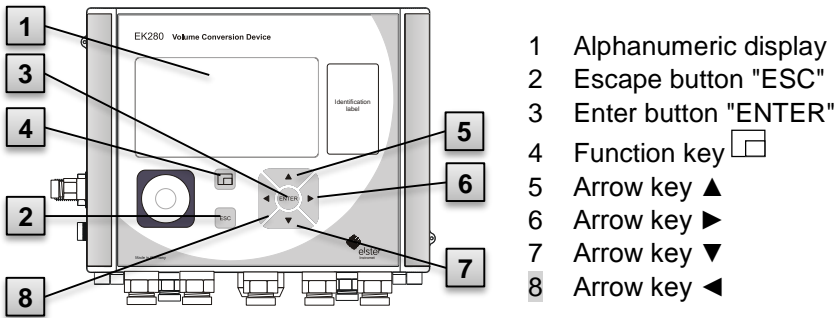

Fig. 23: Front panel of the EK280



The calibration lock is located on the circuit board built into the housing cover in the form of a button, and can be sealed by means of an adhesive label. This button must be pressed in order to adjust the values and parameters protected by configuration regulations. For devices protected by calibration regulations, this may solely be carried out by a calibration officer.

6.3.1 Display

The display is divided into the five registers "Main", "Cust.", "Admin", "Serv." and "Ctrl." under which measurements, settings and other data are displayed.

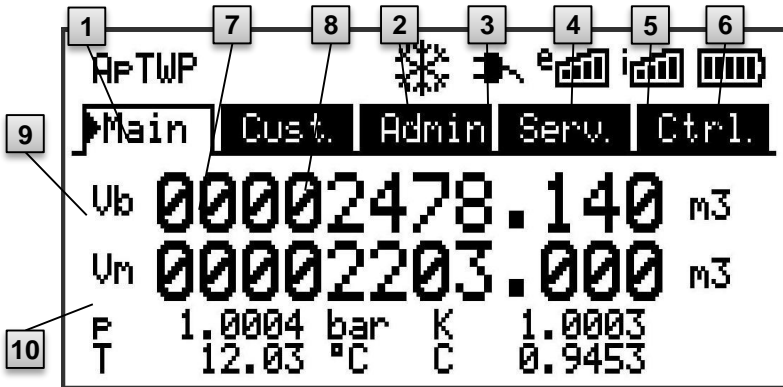



Fig. 24 Display layout

- | | |
|--|-------------------------|
| 1 Device status | 6 Battery charge status |
| 2 Frozen display | 7 Active register |
| 3 External power supply | 8 Inactive register |
| 4 Reception strength of the external modem | 9 Cursor |
| 5 Reception strength of the internal modem | 10 Data field |

The display in the data field in Fig. 24/10 (starting here with "Vb") is different in each of the registers. All other display sections (in the top part of the screen) remain the same, regardless of the register displayed.

6.3.2 Button functions

The pressure and arrow buttons have the following functions:

Button	Function
▶	<ul style="list-style-type: none"> ■ Jump right to another data list. ■ Jump to the second part of a two-part value.
▼	<ul style="list-style-type: none"> ■ Jump down through a data list.
◀	<ul style="list-style-type: none"> ■ Jump left to another data list.
▲	<ul style="list-style-type: none"> ■ Jump up through a data list.
ENTER	<ul style="list-style-type: none"> ■ Depending on the respective data class, you can: <ul style="list-style-type: none"> ● Activate the input mode. ● Open the respective sub-menu. ● Update the corresponding measurement.
ESC	<ul style="list-style-type: none"> ■ Depending on the respective data class, you can: <ul style="list-style-type: none"> ● Leave a sub-menu and jump to its entry value (one menu level up). ● Delete an input (input mode).
◀ + ▲	<ul style="list-style-type: none"> ■ By pressing both of the buttons at the same time: <ul style="list-style-type: none"> ● You can display the "Main" register. ● You can set a value in input mode (reset to start value)
◀ + ▶	<ul style="list-style-type: none"> ■ Address display of the current value.
	<ul style="list-style-type: none"> ■ By pressing the function key, you can: <ul style="list-style-type: none"> ● Display the "Main" register. ● Freeze the current display. ● Delete the status register.

6.3.3 Data recall, display navigation

Using the arrow keys ►, ◀, ▲, ▼, you can move the cursor around the display and switch to the other values.

By pressing the ESC button one or more times, you will be directed to the "Main", "Cust.", "Admin", "Serv." or "Ctrl." registers (→ 6.3.1, Fig. 24). The active register over which the cursor is hovering, is presented with a light-colored background (Fig. 25/1). In the "register" bar, you can move the cursor to other registers using the arrow keys ► and ◀ to display their content. The "Cust." register contains more data than can simultaneously be displayed. The arrow key ▼ is used to move the cursor from the register to the data field (the bottom part of the display). By moving the cursor to the lowest visible value, the display can be shifted upwards by re-pressing the ▼ button to display further data. The ▲ button can also be used to move the cursor and therefore the display upwards by moving to the highest visible value.

If the cursor hovers over a value which has been saved with a corresponding timestamp, it will automatically display this value. (Fig. 25/2)

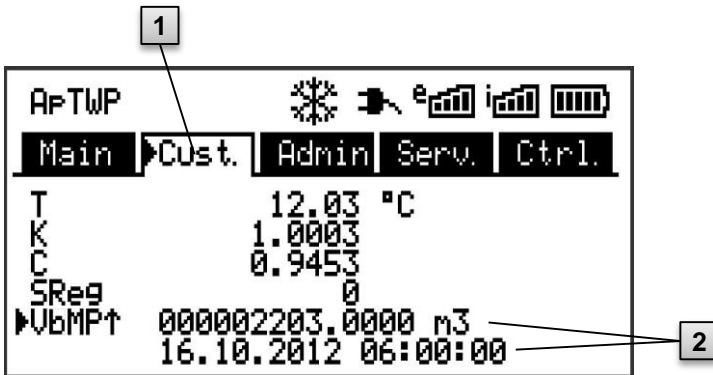

Fig. 25: "Cust." register

- 1 Active register
- 2 Value with corresponding timestamp

6.3.4 Meaning of status symbols

The status symbols displayed in the first line have the following meaning:









Fig. 26: Status symbols in the display

Symbol	Meaning
APTWP	In the upper left-hand side of the screen, individual letters are displayed as symbols for the following signals:
ok.	No special message.
A	Alarm – Collective message for "any alarm"
p	Pressure alarm – The gas pressure cannot be measured
T	Temperature alarm – The gas temperature cannot be measured
W	Warning – Collective message for "any warning"
B	Battery warning – The battery is almost empty
L⁴	Certification data log - The certification data log is full
P	Calibration lock ("programing mode") - The calibration lock is open
M	Measurement error - The connected gas meter encoder is not giving accurate meter readings
o	Online – A data transfer is underway
a	Administrator lock is open

If one of these letters (above) flashes, the indicated status remains active. If one of the letters is displayed constantly, the indicated status is no longer active but must be acknowledged.

For further details on the meaning and potentially necessary procedures, see chapter 8.1.4 "Behavior in the event of faults"

⁴ If a configuration log is in a device.

Symbol	Meaning
	<p>Frozen display</p> <p>The displayed values have "frozen" (are not up-to-date). The current values will be displayed after pressing any button. The display freezing can be caused by pressing the function key .</p>
	<p>External power supply</p> <p>If this symbol appears, the EK280 is being supplied power from an external unit connected to the terminals.</p>
	<p>Signal strength of the radio network for the external modem (connected to the terminals). This symbol will only be shown if an external modem has been connected and is active.</p>
	<p>Signal strength of the radio network for the internal (in-built) modem.</p> <p>This symbol will only be shown if the in-built modem is active.</p>
	<p>Charge status of the battery</p>

6.3.5 Error messages when entering values

If a value has been entered incorrectly via the keyboard, input error messages will be displayed.

This is shown as follows: --x-- with x = error code according to the following table

Code	Description
1	The archive is empty. No values have been entered.
2	The archive value cannot be read. The archive may already have been opened by the interface for readings.
4	This parameter cannot be changed (constant).
5	You are not authorized to change this value. To change this value, a corresponding lock must be opened.
6	Invalid value The value entered is outside the permissible limits.
7	Incorrect code The code entered (numerical code) is incorrect; the lock will not be opened.
11	Input not possible due to special settings or configuration, e.g. - The input of <i>Vm</i> and <i>VmD</i> is not possible in encoder mode. - The calorific value can only be changed in the gas analysis list; not in the energy list.
12	The input of this source (address) is not permitted.
13	Entry based on specific setting or configuration not possible, e.g.: - This function „ <i>Clr.X</i> “ can only be performed once the time has been set to its start value with the key combination ◀ + ▲. - The function „ <i>Store</i> “ can only be performed once the change information for comparison of „ <i>Vm</i> “ (see chapter 5.3.1.14) or „ <i>Vb</i> “ (see chapter 5.3.1.9) has been deleted.
14	Gas analysis parameters do not correspond.
20	Value has not been defined for the user-specific display. The displayed value can be defined by the user by entering the address. As this address has not yet been entered, no value will be displayed.
21	The value can only be changed when the calibration lock is open as the PTB log is full.

6.3.6 Access rights

The following parties can access the EK280.

Access	Meaning
C	Calibration officer
CDL ⁵	Certification data log
A	Administrator
Cu	Customer
-	No access

Each access party has one lock and a corresponding key.

The access rights apply for entries made via the keyboard, and for access via the optical, electrical (hard-wired) or integrated modem interface. If the lock is closed, all attempts to enter values will result in a corresponding error message being displayed (see chapter 0, "

Error messages when entering values").

For data protection reasons, reading values from the interfaces is only possible if one of the locks is open.

6.3.6.1 Calibration lock

The calibration lock is used to protect parameters subject to calibration regulations. This includes all values which influence volume readings or the volume conversion.

The calibration lock is designed as a button which is positioned inside the EK280 housing underneath the circuit board cover. It can be protected with an adhesive label (see chapter 5.3.1.1, "Opening the calibration lock").

The calibration lock is opened by pressing the button ("P" symbol flashes in the display) and is closed again by pressing the same button ("P" symbol fades). It can also be closed by deleting the value "St.PL" (see chapter 6.4.6, "Ctrl." register (Control)) via the keyboard or interface. Using the configuration software "enSuite", a time can also be set (in minutes) after which the calibration lock will automatically close.

The level of protection can be changed for all parameters upon request, particularly for applications which are not subject to German calibration guidelines or the MID.

For example, parameters which are protected by the calibration lock as standard, can also be protected with a administrator's lock or a certification data log.

⁵ If a configuration log is in a device.

6.3.6.2 Certification data log

The certification data log is activated as standard but can also be disabled. The corresponding parameters will then be protected by the calibration lock.

Using the "certification data log" as per PTBA 50.7, several parameters subject to calibration regulations can also be adjusted when the calibration lock is closed. This is subject to the following conditions:

- The administrator's lock (see below) must be open.
- There are at least three free entries in the certification data log.

The following parameters are set as default:

- "CP.I1" cp value for input 1
- "MPer" measurement period
- "Md.K" K-factor mode
- "Clr.A" delete measurement archive
- "Md.I1" mode for input 1
- "qMax" maximum flow (plausibility check in encoder mode)

For every change of a parameter listed under "CDL" when the calibration lock is closed, one row of data will be entered for the value before and after the change.

If the certification data log is full, it can be deleted using the command "CICDL" if the calibration lock is open (see chapter 5.3.1.16).



If the calibration lock is opened when the certification data log is full, it can only be closed again after the certification data log has been deleted.

6.3.6.3 Administrator and customer locks

Administrator and customer locks are used to protect data which is not subject to calibration regulations, but which should also not be modified without authorization.

These locks can be opened by entering a code (i.e. the "key") under "Cod.A" or "Cod.C" and are closed by entering "0" for "St.AL" or "St.CL".

These values can be found under the following path:

Admin → *Device settings* → *Access*

or *Serv.* → *Device settings* → *Access*

A time (in minutes) can also be set here for each lock, after which it will automatically close.

6.4 Data register content

6.4.1 Access rights

The "access" column in the tables in the following chapter describes which lock must be opened in order to change a parameter. All parameter changes are saved in a log.

Access	Meaning
C	Calibration officer
CDL ⁶	Certification data log
A	Administrator
Cu	Customer
-	No access

6.4.2 "Main" register (main display)

An overview of the most important measurements is presented in the "Main" register. The contents may vary depending on the parameterization (→ chapter 6.4.6.5).

It is not possible to move the cursor to a value in this register⁷. By pressing the "ENTER" button, the displayed values are updated.

Display	Meaning	Unit	Access	Address
Vb	Volume at base conditions	m ³	C	2:300
Vm	Volume at measurement conditions	m ³	C	4:300
P	Pressure	bar	-	7:310_1
K	Compressibility ratio factor	-	-	8:310
T	Temperature	°C	-	6:310_1
C	Conversion factor	-	-	5:310

6.4.2.1 Vb – Volume at base conditions

The volume measured by the connected gas meter will be converted into a quantity at base conditions and totaled in this counter.

If there is a fault (see chapter 8 "Faults"), the Vb counter will be stopped and the volume will be totaled in a special disturbance quantity counter.

⁶ If a configuration log is in a device.

⁷ The exception is if the „Main“ tab was set to „List“ (see chapter 6.4.6.5).

6.4.2.2 Vm – Volume at measurement conditions

The volume measured by the connected gas meter will be totaled in this counter.

If there is a fault (see chapter 8 "Faults"), the Vm counter will be stopped and the volume will be totaled in a special disturbance quantity counter. To control the measurements, the Vm can be kept at the same level as the gas meter when putting the device into operation (→ chapter 5.3.1 "Configuration of measurement parameters").

6.4.2.3 p – Gas pressure

The measured gas pressure is used to calculate the volume at base conditions. The pressure is displayed as absolute pressure.

If the pressure cannot be measured due to a fault, an adjustable replacement value is displayed and is used to calculate the disturbance quantity. The replacement value is determined when putting the device into operation (→ chapter 5.3.1 "Configuration of measurement parameters").

6.4.2.4 T – Gas temperature

The measured gas temperature is used to calculate the volume at base conditions.

If the temperature cannot be measured due to a fault, an adjustable replacement value is displayed and is used to calculate the disturbance quantity. The replacement value is determined when putting the device into operation (→ chapter 5.3.1 "Configuration of measurement parameters").

6.4.2.5 K – Compressibility ratio factor

The calculated compressibility ratio factor is used to calculate the volume at base conditions.

The EK280 supports several equations to calculate the compressibility ratio factor. The corresponding equation is determined by the applicable guidelines and standards for the area of application of the device. This can be adjusted at the ordering or commissioning phase (→ chapter 5.3.1 "Configuration of measurement parameters").

6.4.2.6 C – Conversion factor

The currently valid factor for converting the volume at measurement conditions to base conditions.

6.4.3 "Cust." register (Customer)

This register is used to display and check special device settings and conditions. This application is provided for gas customers.

This register can be freely programmed by the user via the enSuite configuration software.

The following parameters are programmed in-house:

Display	Meaning	Unit	Access	Address
Time	Date and time	-	-	1:400
Vb	Volume at base conditions	m ³	C	2:300
Vm	Volume at measurement conditions	m ³	C	4:300
p	Pressure	bar	-	7:310_1
T	Temperature	°C	-	6:310_1
K	Compressibility ratio factor	-	-	8:310
C	Conversion factor	-	-	5:310
SReg	Status register (total)	-	-	1:101
VbMP↑	Maximum measurement period counter Vb in the current month	-	-	3:161
VbDy↑	Maximum daily counter Vb in the current month	-	-	4:161
Qb	Flow at base conditions	m ³ /h	-	2:310
Qm	Actual flow rate	m ³ /h	-	4:310

6.4.3.1 Time - Date and time

The displayed time is updated every 30 seconds in battery mode and every 2 seconds in power supply operation.

6.4.3.2 Values from the "Main" register

Vb – Volume at base conditions, see chapter 6.4.2.1

Vm – Volume at measurement conditions, see chapter 6.4.2.2

p – Gas pressure, see chapter 6.4.2.3

T – Gas temperature, see chapter 6.4.2.4

K – Compressibility ratio factor, see chapter 6.4.2.5

C – Conversion factor, see chapter 6.4.2.6

6.4.3.3 SReg – Status register (total)

In the status register all messages since the last manual clearing are collected. Here, you can also see what has happened, for example, since the last station inspection. The messages can be cleared at the device (*Serv. - > Status -> Clr*).

Only alarms and warnings (→ chapter 8.2) are displayed in status registers.

6.4.3.4 VbMP↑ – Maximum measurement period counter Vb in the current month

The maximum time stamp is displayed in the following line after moving the cursor to the value "VbMP↑".

The maximum values from the past 15 months can be requested in the monthly archive 1 (see chapter 6.4.4 "Admin" register (Administrator)).

6.4.3.5 VbDy↑ – Maximum measurement period counter Vb at the current day

The time stamp for the maximum value is displayed in the following line when moving the cursor  to the value "VbDy↑".

The maximum values from the past 15 months can be requested in the monthly archive 1 (see chapter 6.4.4 "Admin" register (Administrator)).

6.4.3.6 Qb – Flow at base conditions

Current flow at base conditions (standard flow rate)

$$Q_b = Q_m \cdot C \quad \text{with } Q_m = \text{actual flow rate} \\ C = \text{Conversion factor}$$

The maximum inaccuracy of the displayed value roughly corresponds to the maximum inaccuracy of the Q_m .

For the alarm, the Q_b is calculated with the replacement values of the disturbed measurements.

6.4.3.7 Qm – Actual flow rate

Current actual flow rate (measurement flow rate)

The measurement inaccuracy of the displayed actual flow rate is dependent on whether a pulse transducer or encoder is connected:

If a pulse transducer is connected:

For a maximum pulse interval of 15 minutes (at least four pulses per hour) and

$cp.11 \leq 1$, the measurement inaccuracy of Q_m is maximum 1%. For a pulse interval of more than 15 minutes, $Q_m = "0"$ will be displayed. After the gas flow rate has changed, the precise value can only be displayed if at least two pulses have been transmitted to the gas meter.

If an encoder is connected:

If the meter reading changes every two seconds or less, the measurement inaccuracy of Qm will be max. 1%.

If the meter reading changes every 200 seconds or less, the measurement inaccuracy will be max. 10%. This can be reduced by decreasing the measurement cycle (Serv. -> *Device settings* -> *Measurement* -> *MCyc*) by up to 2% for MCyc = 4 seconds.

If the meter reading of the encoder does not change after 200 seconds, Qm = "0" will be displayed.

6.4.4 "Admin" register (Administrator)

This register is used to display and check special device settings and conditions. This application is provided for metering point operator.

Display	Meaning
User values ⁸	Sub-menu for user-specific parameters
Volume	Sub-menu for volume and the corresponding parameters
Volume conversion	Sub-menu for volume conversion and the corresponding parameters
Measured values	Sub-menu for measured values and the corresponding parameters
Archives	Sub-menu for existing archives in the device
Status	Sub-menu for current status, status register and logs
Date and time	Sub-menu for date, time and the corresponding parameters
Batteries	Sub-menu for the device battery and the corresponding parameters
Inputs	Sub-menu for inputs and the corresponding parameters
Outputs	Sub-menu for all outputs and the corresponding parameters
Interfaces	Sub-menu for device interfaces
Device settings	Sub-menu for all device settings
Identification	Sub-menu for the identification of the gas system

⁸ In the "User Values" sub-menu, the user can set up to 10 freely programmable parameters and up to 12 freely programmable parameters in a further sub-menu within this list.

6.4.5 "Serv." register (service)

This register is used to display, check and configure special device settings and conditions. This application is only intended for service technicians (specialists) or a calibration officer for putting the device into operation or maintenance.

Display	Meaning
Volume	Sub-menu for volume and the corresponding parameters
Volume conversion	Sub-menu for volume conversion and the corresponding parameters
Measured values	Sub-menu for analog measurements and the corresponding parameters
Archives	Sub-menu for existing archives in the device
Status	Sub-menu for current status, status register and logs
Date and time	Sub-menu for date, time and the corresponding parameters
Batteries	Sub-menu for device battery and the corresponding parameters
Inputs	Sub-menu for inputs and the corresponding parameters
Outputs	Sub-menu for all outputs and the corresponding parameters
Interfaces	Sub-menu for device interfaces
Device settings	Sub-menu for all device settings
Identification	Sub-menu for the identification of the gas system
Edit and delete	Sub-menu to activate a range of delete functions
Examination	Sub-menu with freeze function and archive with frozen data
Data book	Sub-menu with information from the device data book

6.4.6 "Ctrl." register (Control)

This register is used to monitor special device settings. This application is only intended for service technicians (specialists) or a calibration officer for putting the device into operation or maintenance.

Display	Value	Unit	Access	Addresses
St.AL ⁹	Administrator lock: State / close	-	-	3:170
Cod.A ⁹	Administrator key enter / change	-	-	3:171
St.PL	Calibration lock: State / close	-	-	1:170
Menu	Selection of the display menu	-	C	1:1A1
Main	Content of the "Main" register	-	A	2:1A1

6.4.6.1 St.AL – Administrator lock: State / close

The administrator lock must be opened in order to modify certain measurement parameters. The administrator lock should be closed when in normal operating mode.

Display	Meaning
locked	The administrator lock is closed.
open	The administrator lock is open.

6.4.6.2 Cod.A – Administrator key enter / change

By entering the right key (hexadecimal notation) the administrator lock can be opened. After the administrator lock is open the key can be changed. The individual characters of the key can take on values from 0 to 9 and from A to F.

6.4.6.3 St.PL – Calibration lock: State/close

The calibration lock must be opened in order to modify certain measurement parameters. The calibration lock should be closed when in normal operating mode.

Display	Meaning
locked	The calibration lock is closed.
open	The calibration lock is open. In this case, the "P" will also flash in the upper left-hand side of the display (see chapter 6.3.4 "Meaning of status symbols")

⁹ When using the device with high communication security („High Level Security“, see application manual), the parameter will not be displayed.

6.4.6.4 Menu - Selection of the display menu

In an as-delivered condition, the display of the EK280 has the following five registers: "Main", "Cust.", "Admin", "Serv." and "Ctrl.". Registers can be displayed and hidden for certain purposes using the "Menu" value.

6.4.6.5 Main – Content of the "Main" register

The content of the "Main" display register can be adjusted here.

The default setting is "volume+meas.". This corresponds to the content displayed in chapter 6.3.1.

Display	Meaning
vol- ume+meas.	<ul style="list-style-type: none"> - The following are displayed: Volume at base conditions, volume at measurement conditions, pressure, temperature, compressibility ratio factor and conversion factor - Format: 8 pre-decimal and 3 post-decimal places for counters - With short descriptions for each value
volume short	<ul style="list-style-type: none"> - The following are displayed: Volume at base conditions and volume at measurement conditions - Format: 8 pre-decimal and 3 post-decimal positions respectively - With short descriptions
volume long	<ul style="list-style-type: none"> - The following are displayed: Volume at base conditions and volume at measurement conditions - Format: 9 pre-decimal and 4 post-decimal places - Without short descriptions
volume, p, T, Q	<ul style="list-style-type: none"> - The following are displayed: Volume at base conditions, volume at measurement conditions, pressure, temperature, flow at base conditions and actual flow rate - Format: 8 pre-decimal and 3 post-decimal places for counters - With short descriptions for each value
List	<ul style="list-style-type: none"> - The following are displayed: Volume at base conditions, volume at measurement conditions, total meter reading the original meter reading of the gas meter at Input DE1, pressure, temperature, Conversion factor, compressibility ratio factor, actual flow rate, flow at base conditions, date and time
Vb, Vo, meas.	<ul style="list-style-type: none"> - The following are displayed: Volume at base conditions, meter reading of the gas meter (Encoder), pressure, temperature, compressibility ratio factor and conversion factor - Format: 8 pre-decimal and 3 post-decimal places for counters - With short descriptions for each value

7 Maintenance

7.1 Safety



DANGER!

Danger to life from electrical current!

Touching live parts poses an imminent danger to life. Damage to the insulation or individual components may be life-threatening.

Therefore:

- Safely protect electrical connections and live components against possible human contact.
- In the event of insulation damage, switch off the power supply immediately and arrange for repairs to be carried out.
- Works on the electrical components of the device, i.e. the connection of the external power supply unit, should only be carried out by qualified electricians.
- When performing all works to the electrical system, switch off the power and ensure that the voltage has been cut.
- Before performing maintenance works, switch off the power supply and protect against an accidental restart.
- Do not attempt to bypass or deactivate fuses. When exchanging fuses, ensure that you adhere to the correct ampere rating.
- Keep live parts away from moisture. This could lead to a short-circuit.

**WARNING!****Misuse of batteries may present a risk of injury.**

Special care must be taken when handling batteries.

Therefore:

- Do not throw the batteries into the fire or expose these to high temperatures. There is a risk of explosion.
- Do not charge batteries. There is a risk of explosion.
- Liquids that are produced as a result of misuse may lead to skin irritation. Avoid all contact with liquids. In the event of contact, rinse with large quantities of water. If the liquid enters the eyes, immediately rinse with water for 10 minutes and seek medical attention.

**CAUTION!****Environmentally hazardous substances!**

If environmentally hazardous substances are handled incorrectly this may cause significant damage to the environment, particularly if they are improperly disposed of.

Therefore:

- The instructions below should be observed at all times.
- Appropriate measures should be taken immediately if environmentally hazardous substances are accidentally released into the environment. In cases of doubt, please inform the responsible local authority about the damages.

7.1.1 Personnel

Maintenance works must be carried out correctly.

- The maintenance works described in this document should solely be carried out by specialized electricians (see "Operation" chapter).



WARNING!

Risk of injury if maintenance works are carried out incorrectly.

Incorrect maintenance may lead to serious personal injury or material damage.

Therefore:

- Ensure that there is sufficient assembly space before commencing works.
- Ensure that the installation location is clean and tidy. Components that are loosely stacked or lying around can cause accidents.
- If parts have been removed, ensure that they have been installed correctly, re-mount all fastenings, and adhere to tightening torque values for screws.

7.1.2 Personal protective equipment

- During maintenance works on the device, the necessary personal protective equipment for the work must be worn inside the respective plant.
- The notices relating to personal protective equipment mounted in the working area must be followed at all times.

7.1.3 Environmental protection

Please observe the following notice regarding environmental protection when performing maintenance works:



The batteries used contain toxic heavy metals. These must be treated as special hazardous waste and must be disposed of in municipal waste collection points or by a waste specialist.

7.2 Testing and changing device batteries

7.2.1 Changing and connecting device batteries



DANGER!

Using the incorrect batteries may present a risk of explosion!

Connect only the prescribed Elster battery-types to the device (see chapter 9.1.4.



WARNING!

Misuse of batteries may present a risk of injury.

Special care must be taken when handling batteries.

Therefore:

- Do not throw the batteries into the fire or expose them to high temperatures. There is a risk of explosion.
- Do not charge the batteries. There is a risk of explosion.
- Liquids that are produced as a result of misuse may lead to skin irritation. Avoid all contact with liquids. In the event of contact with the skin, rinse with plenty of water. If the liquid enters the eyes, immediately rinse with water for 10 minutes and seek medical attention.



CAUTION!

Reduced battery power!

The simultaneous use of old and new batteries considerably reduces battery power.

Therefore:

- You should always replace all batteries together.

The batteries can be exchanged without a calibration officer as the housing does not need to be sealed.



In an as-delivered condition, two batteries are connected to the base board of the EK280. To double the service life of the batteries, two additional batteries can be connected.



You should always connect at least two batteries (to X10 and X13 or X11 and X14) to the EK280. This way, the EK280 will continue to work whilst the batteries are being changed.

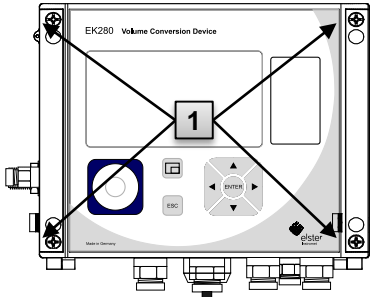

Fig. 27

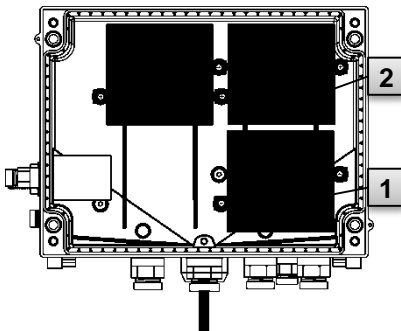

Fig. 28

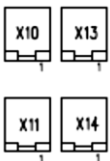

Fig. 29

1. If the external power supply is connected, this should be removed.
2. Loosen the four screws Fig. 27: **1** which are keeping the housing closed.
3. Open the cover of the EK280.
4. Loosen the screws on the battery cover Fig. 28: **1** or **2** and remove the battery cover.
5. Mark the old batteries, e.g. using a felt-tipped pen or stickers.
6. Select the two free connections on the board to connect the new batteries (X10 and X13 or X11 and X14, Fig. 29).
7. Place the new batteries inside (Fig. 28: **1** or **2**).
8. Position the new batteries and secure them using the battery cover.
9. Remove the old batteries from the housing and dispose of these correctly.
10. Close the housing using the screws provided (Fig. 27: **1**).
11. Re-enter the start capacity of the batteries, as described in chapter 7.2.2.
12. Check the calculated service life as described in chapter 7.2.3. At standard measurement conditions (see chapter 3.2.1), the service life should display at least 60 months. If not, compare the settings with those for standard measurement conditions and repeat step 11 if necessary.



Please ensure that the new batteries are connected correctly and are in a fixed position inside the EK280.



CAUTION!

Material damage may arise through improper closing of the device!

Improper closing of the device may lead to material damage as a result of cable connections being squashed.

Therefore:

- When closing, ensure that the cable ducts are positioned correctly.

7.2.2 Entering the battery capacity



The battery capacity must be re-entered after changing a battery.

When using the device with high communication security („High Level Security“, see application manual), the battery capacity can only be entered with the enSuite software!

- For opening the administrator lock move the cursor to the "Admin" register and to the "Cod.A" value (enter administrator key) via the following path::

Admin. → Device settings → Access → Cod.A



After delivery of the device, the administrator key for input via keypad is "00000000".

- Press the ENTER button ⇒ The value will start to flash.
- Move the cursor using the arrow keys ► or ◀ to the digits and change these using the arrow keys ▲ or ▼.
- After you have changed all digits, press the ENTER button to confirm the inputs. The input value can be deleted by pressing the ESC button.
- For entering the battery capacity move the cursor to the "Serv." register and to the "Bat.C" value (battery capacity) via the following path:

Serv. → Batteries → Bat.C

- Press the ENTER button ⇒ The value will start to flash.
- Move the cursor using the arrow keys ► or ◀ to the digits and change these using the arrow keys ▲ or ▼.



When using two size D batteries, the value 13.0 Ah should be entered for "Bat.C". When using four batteries, the value 26.0 Ah must be entered.

- After you have changed all digits, press the ENTER button to confirm the inputs. The input value can be deleted by pressing the ESC button.

- For closing the administrator lock move the cursor to the "Admin" register and to the "St.AL" value (status administrator lock) via the following path:
Admin. → Device settings → Access → St.AL
- Press the ENTER button ⇒ "open" will start to flash.
- Move the cursor using the arrow keys ▲ or ▼ to change the value to "locked".
- After you have changed the value, press the ENTER button to confirm the inputs. The input value can be deleted by pressing the ESC button.

7.2.3 Display remaining battery power



The remaining battery power is calculated separately from the consumed power (which is measured) and from the anticipated future consumption (giving the theoretical remaining battery power). Therefore, for applications which are very power-consuming, the remaining battery power may drop quicker than is shown on the battery power display.

The remaining battery power will automatically be recalculated after entering a new battery capacity "Bat.C" (see above). The value cannot be edited.

- Move the cursor to the "Serv." register and to the "Bat.R" value (remaining battery power) via the following path:
Serv. → Batteries → Bat.R



After entering the new battery capacity, a value of at least 60 months will be displayed in standard measurement conditions (see chapter 3.2.1) for "Bat.R".

8 Faults

Possible causes and solutions for device faults will be described in the following chapter.



For faults, which cannot be resolved by the instructions below, please contact our customer service team (see chapter General) or our Electronic Hotline:

Tel. +49 (0) 6134 / 605-123

<http://www.elster-instromet.com/de/support>

E-Mail: ElsterSupport@honeywell.com

8.1 Safety



DANGER!

Danger to life from electrical current!

Touching live parts poses an imminent danger to life. Damage to the insulation or individual components may be life-threatening.

Therefore:

- In the event of insulation damage, switch off the power supply immediately and arrange for repairs to be carried out.
- Works on the electrical components of the device, i.e. the connection of the external power supply unit, should only be carried out by qualified electricians.
- When performing all works to the electrical system, switch off the power and ensure that the voltage has been cut.
- Before performing maintenance works, switch off the power supply and protect against an accidental restart.
- Keep live parts away from moisture. This could lead to a short-circuit.

8.1.1 Personnel

- The works described below for the elimination of a fault can, unless specified otherwise, be performed by the operator.
- Some works may only be carried out by specially trained professionals or exclusively by manufacturers themselves; special reference will be made to this in the descriptions of individual faults.

- Works on the electrical appliance may only be carried out by qualified electricians.

8.1.2 Personal protective equipment

- When eliminating faults on the device, the necessary personal protective equipment for the work must be worn inside the respective plant.
- The notices relating to personal protective equipment mounted in the working area must be followed at all times.

8.1.3 Improper elimination of faults



WARNING!

Risk of injury through improper elimination of faults!

An improper elimination of faults on the device may lead to serious personal injury or material damage.

Therefore:

- Ensure that there is sufficient assembly space before commencing works.
- Ensure that the installation location is clean and tidy. Components that are loosely stacked or lying around can cause accidents.
- If parts have been removed, ensure that they have been installed correctly, re-mount all fastenings, and adhere to tightening torque values for screws.



The following information on possible faults provide indications as to who is authorized to eliminate the fault.

8.1.4 Behavior in the event of faults

The following generally applies:

1. If works in the danger zone are necessary, the entire plant must be switched off and protected against an accidental restart.
2. The cause of the fault must be determined.
3. The person responsible for the area in which the fault occurred should be informed immediately.
4. Depending on the type of fault, the manufacturer may have to be contacted and will then have the fault removed by an authorized specialist, or will remove the fault themself.

8.2 Fault and other status messages

Faults (synonymously used here for "alarms") during the operation of the EK280, can be identified by means of status symbols in the first line of the display (see chapter 6.3.4).

You can obtain further information and messages under the current status "Stat" and in the status register "SReg". These can be found:

- In the "Cust." register (only "SReg")
- Under the paths: *Admin* → *Status* and *Serv.* → *Status*

Effects and recommended action in the event of fault and status messages:

Message	Meaning, action
a) Faults, alarms:	
Restart	If this message appears whilst in operation, the device is faulty. Please contact the Elster support(see chapter 1.3 "Customer service").
C-fact. err.	The conversion factor could not be calculated as the measured gas temperature was outside -100°C to +100°C or no usable compressibility ratio factor was available.
Data error	An error was detected during the cyclic check of the data subject to calibration regulations. Please contact the Elster support(see chapter 1.3 "Customer service").
T Alarm Lim.	The measured gas temperature is outside the permissible limits. The limit values can be changed when putting the device into operation in the presence of a calibration officer (see chapter 5.3.1.11, page 52)
p Alarm Lim.	The measured gas pressure is outside the permissible limits. The limit values can be changed when putting the device into operation in the presence of a calibration officer (see chapter 5.3.1.11, page 52)
K-val. error	The compressibility ratio factor could not be calculated as no valid real gas factor could be determined.
z-fact. err.	The real gas factor could not be calculated. At least one of the gas analysis values Ho.n, CO2, H2, rhon, is outside the permissible range.
Vm-Alarm	No volume was recorded at the used input for conversion. (The automatic switchover of the pulse transducer to a second pulse transducer is not configured acc. chapter 5.2.1.4.).

Message	Meaning, action
Vm-Inp.Alarm	No volume at measurement conditions was recorded at the connected encoder on input 1 for 20 seconds (with ext. power supply) or for two measurement cycle + 1 second (battery powered).
T Inp. error	The gas temperature cannot be measured due to a fault. Please contact the Elster support (see chapter 1.3 "Customer service").
p Inp. error	The gas pressure cannot be measured due to a fault. Please contact the Elster support (see chapter 1.3 "Customer service").
b) Warnings:	
Data restore	<p>The batteries of the EK280 are intermittently dropping out. As a result of this, the time has not changed and no measurement and volume conversion have happened. However, all data is available.</p> <p>This message appears when old batteries are removed before connecting the new ones (see chapter 7.2, page 80).</p> <p>Proceed with the help of the configuration program "enSuite":</p> <ul style="list-style-type: none"> ■ Set the time of the EK280 ■ Delete the status register
Outp.1 Error Outp.2 Error Outp.3 Error Outp.4 Error	<p>There should be more pulses being emitted from the specified output than are permitted under its configured settings.</p> <p>In order to eliminate the cause of the problem, you can use the configuration program "enSuite" to either:</p> <ul style="list-style-type: none"> ■ reduce the cp value of the output ■ or increase the output frequency. <p>In both cases, the change must be aligned with the connected device.</p>
I1-Warning	The encoder could not be read at the end of the measurement period. The flow recording at this point is invalid.
I2 Pulse cmp	In the pulse comparison, e.g. between input 1 and input 2, the deviation was too high.
W Warn Lim.	<p>The displayed value is outside the set warning limit values.</p> <p>The warning limits can be adjusted using the configuration program "enSuite".</p>

Message	Meaning, action
Vb Warn Lim.	<p>The monitored volume at base conditions consumption value (standard: hourly consumption) is outside the set warning limit values.</p> <p>The monitored values and the warning limits can be adjusted using the configuration program "enSuite".</p>
Qm Warn Lim.	<p>The actual flow rate (gas flow rate) is outside the set warning limit values. The warning limits can be adjusted using the configuration program "enSuite".</p>
T Warn Lim.	<p>The measured gas temp. is outside the warning limit values.</p> <p>The warning limits can be adjusted using the configuration program "enSuite".</p>
p Warn Lim..	<p>The measured gas pressure is outside the warning limit values.</p> <p>The warning limits can be adjusted using the configuration program "enSuite".</p>
z Warning	<p>The sum of gas analysis values for AGA-8 DC92 is more or less than 100%. An accurate calculation of the real gas factor and the compressibility ratio factor can therefore not be carried out.</p>
Vm warning	<p>If a HF-NF switch is configured, then this message is enabled in the event of a fault at the HF input, e.g. loss of external power supply.</p>
Update error	<p>Before the software update, an error was detected in the cached software image.</p>
Softw. error	<p>This message is used for factory diagnosis. Please contact the Elster support (see chapter 1.3 "Customer service").</p>
Sett. error	<p>The programming of the device has generated an unusable combination of settings. Please contact the Elster support (see chapter 1.3 "Customer service").</p>
I2 Warn.sig. I3 Warn.sig. I4 Warn.sig. I5 Warn.sig. I6 Warn.sig.	<p>If an input has been configured as a warning input, this message will be displayed if an active signal appears at the corresponding terminal (e.g. terminal DE2).</p> <p>The input configuration can be adjusted using the configuration program "enSuite".</p>
T2 Warn Lim.	<p>The measured gas temperature of the second sensor is outside the set warning limit values.</p> <p>The warning limits can be adjusted using the configuration program "enSuite".</p>

Message	Meaning, action
p2 Warn Lim.	The measured gas pressure of the second sensor is outside the set warning limit values. The warning limits can be adjusted using the configuration program "enSuite".
Batt. low	The remaining battery power is less than six months. The batteries need to be changed soon.
c) Signals:	
TA Warn Lim.	The measured ambient temperature is outside the set warning limit values. The warning limits can be adjusted using the configuration program "enSuite".
Repair mode	The device is in revision mode.
Clock n. set	The internal clock of the volume corrector has not been adjusted at the factory.
Encoder err.	No volume at measurement conditions was recorded at the connected encoder on input 1 for 20 seconds (with ext. power supply) or for one measurement cycle + 1 second (battery powered).
CDL full	The certification data log is full. Changing the parameters marked with "CDL" without a calibration lock is only possible if the content of the certification data log has been deleted.
U.Logb. full	The software update log is full. An update is only possible if the content of the software update log has been deleted.
online	Data is currently being transmitted via an interface (modem, optical interface or terminal interface). If this message is displayed, the "o" will flash in the "Status" field of the display (see chapter 6.3.4, page 63).
I2-Rep.sig I3-Rep.sig I4-Rep.sig I5-Rep.sig I6-Rep.sig	If an input has been configured as a signal input, this message will be displayed if an active signal has appeared at the corresponding terminal (e.g. terminal DE2). The input configuration can be adjusted using the configuration program "enSuite".
Remote clock	The volume corrector has started to display its time via remote data transmission. It will be deleted again once this has successfully been carried out. If this message appears for more than several minutes, the function "Automatically set time via RDT" is activated. However, if this does not work, please contact the Elster support (see chapter 1.3 "Customer service").

Message	Meaning, action
Cal.lock o.	<p>The calibration lock is open.</p> <p>In normal operating conditions, the calibration lock should be closed to prevent unauthorized changes.</p> <p>To close the calibration lock, please go to <i>Ctrl.</i> → <i>St.PL</i> and enter the value "0".</p>
Admin.lock Cust.lock o.	<p>The administrator / customer lock is open.</p>
Bat. operat.	<p>The EK280 is in battery mode.</p> <p>This signal is primarily used to inform a remote data transmission system that the batteries run down more quickly during long periods of data transmission.</p>
Dayl.Sav.Tim	<p>The time displayed in volume corrector is daylight saving time.</p> <p>The switchover mode can be changed using the configuration program "enSuite".</p>
Call Win.1 Call Win.2 Call Win.3 Call Win.4 Call Win.5 Call Win.6	<p>The specified call pickup time is active, i.e. the volume corrector will accept data transmission calls.</p>

9 Appendix

9.1 List of spare parts and accessories



Images of the spare parts and accessories described below can be found in the manufacturer's catalog which is available to order under www.elster-instromet.com.

9.1.1 Fastening elements

Spare parts and accessories	Order no.
Set mounting bracket EK220/280 for MI-2	73 021 952
Set mounting bracket EK220/280 for Rabo	73 021 953
Set mounting bracket EK280 for S1/Encoder	73 021 954
Set Bracket EK/DL for pipe mounting	73 021 955
Universal bracket with pipe clamps for pipe mounting	73 018 057
Mounting bracket for meter head S1D	73 021 050



When ordering the universal bracket with pipe clamps for pipe mounting, please specify the pipe diameter.

9.1.2 Pressure connections

Spare parts and accessories	Order no.
Shut-off valve with t-piece	03 152 266
Three-way check valve	73 008 403
Pressure pipe C2 Ø6 x 700 mm	73 017 659
Pressure pipe C5 Ø6 x 400 mm	73 017 656
Minimess test connections (adapters)	73 016 167

9.1.3 Temperature sensor pockets

Spare parts and accessories	Order no.
Temp. sensor pocket EBL 50, with welded sockets M10 x 1	73 012 634
Temp. sensor pocket EBL 67, with welded sockets M10 x 1	73 014 456
Temp. sensor pocket EBL 160, with welded sockets G 3/4" and sealing ring	73 012 100
Temp. sensor pocket EBL 250, with welded sockets G 3/4" and sealing ring	73 015 695
Sealing sleeve for the connection of an old temp. sensor pocket EBL 45, 50 and 67	73 019 951
Sealing sleeve for the connection of an old temp. sensor pocket EBL 160 and 250	73 019 950

9.1.4 Small parts and miscellaneous

Spare parts and accessories	Order no.
Sealing sleeve for pressure connection and temp. sensor	73 017 997
Connecting cable for two low frequency pulser transducers, approx. 700 mm long	73 017 093
Device battery module 13 Ah	73 015 774
Device battery module 13 Ah ¹⁰	730 23 225
16 Ah battery module for the modem of the EK280 without integrated power supply unit	73 021 211
13 Ah battery module for connection to the integrated power supply unit (modem battery mode in the event of power failure)	73 017 964
Ext. GSM antenna, 3 m connecting cable, SMA connector	04 407 115
Ext. GSM antenna, 5 m connecting cable, SMA connector	04 407 116
Ext. GSM antenna, 10 m connecting cable, SMA connector	04 407 117
10 m antenna extension cable with SMA connector	73 020 149
2G/3G stub antenna, SMA, straight	04 407 113
Breather Drain Plug for outdoor application	73 020 775

9.1.5 Documentation

Spare parts and accessories	Order no.
German manual	73 021 805
English manual	73 021 209

¹⁰ After consultation for special applications.

9.2 EC Declaration of Conformity



EU Declaration of Conformity No. **DEMZE1719**
EU-Konformitätserklärung Nr.

Honeywell

Type, Model
Typ, Ausführung

EK280

Manufacturer
Hersteller

Elster GmbH, Postfach 1880, D - 55252 Mainz-Kastel; Steinern Straße 19-21

Product
Produkt

Volume conversion device
Zustands-Mengennumwerter

The object of the declaration described above is in conformity with the relevant Union harmonisation legislation:
Der oben beschriebene Gegenstand der Erklärung erfüllt die einschlägigen Harmonisierungsrechtsvorschriften der Union:

2014/32/EU (MID)	2014/30/EU (EMC)	2014/34/EU (ATEX)	2014/34/EU (ATEX)	2014/53/EU (RED)	2011/65/EU (RoHS)
---------------------	---------------------	----------------------	----------------------	---------------------	----------------------

Relevant harmonised standards used:

Einschlägige harmonisierte Normen, die zugrunde gelegt wurden:

EN 12405-1:2011-04, OIML D11 Edition 2004 (E)	EN 61326-1:2013	EN 60079-0:2012 + A11:2013, EN 60079-11:2012	EN 60079-0:2012 + A11:2013, EN 60079-15:2010, EN 60079-11:2012	EN 301511 V9.0.2, EN 301908-1 V11.1.1, EN 301908-2 V11.1.1	EN 50581:2012
---	-----------------	--	---	--	---------------

Certificates and interventions by notified bodies:

Bescheinigungen und Maßnahmen durch notifizierte Stellen:

T10339	-	LCIE 11 ATEX 3027 X	LCIE 12 ATEX 1015 X	-	-
EC-type Examination EG-Baumusterprüfung		EC-type Examination EG-Baumusterprüfung	Voluntary supplementary Type Examination Freiwillige ergänzende Baumusterprüfung		
Notified Body 0122 NMI Certin B.V. Hugo de Grootplein 1 NL-3314 EG Dordrecht		Notified Body 0081 Bureau Veritas LCIE 33, avenue du Général Leclerc F-92260 Fontenay-aux-Roses			

This declaration of conformity is valid for products labelled accordingly:

Diese Konformitätserklärung gilt für entsprechend gekennzeichnete Produkte:

M... 102		0044			
T10339		II 1 G Ex ia IIB T4 or T3 Ga	II 3 G Ex nA IIC T6 Gc II 3(3) G Ex nA[Ic] IIC T6 Gc		

The production is subject to the following surveillance procedures:

Die Herstellung unterliegt folgenden Überwachungsverfahren:

Directive Module D Richtlinie Modul D	Directive Module C Richtlinie Modul C	Directive Annex IV + VII Richtlinie Anhang IV + VII	Directive Annex II Richtlinie Anhang II	Directive Article 7 Richtlinie Artikel 7
Notified Body 0102 Physikalisch Technische Bundesanstalt (PTB) D-38116 Braunschweig		Notified Body 0044 TÜV NORD CERT GmbH D-30519 Hannover		

This declaration of conformity is issued under the sole responsibility of the manufacturer. If alterations are made to the product or it is modified, this declaration becomes void with immediate effect.

Die alleinige Verantwortung für die Ausstellung dieser Konformitätserklärung trägt der Hersteller. Bei Umbau des Produkts oder Änderungen am Produkt verliert diese Erklärung mit sofortiger Wirkung ihre Gültigkeit.

Elster GmbH

Mainz-Kastel, 24.08.2017

Signed for and on behalf of
Unterszeichnet für und im
Namen von

Place and date of issue
Ort und Datum der
Ausstellung

Piet Platschorre,
Managing Director, General
Manager PMC Europe

Jörg Kern,
Sr R&D Manager
Gas Metering

9.3 ATEX Type Examination Certificate

9.3.1 Zone 1



L C I E

1 ATTESTATION D'EXAMEN CE DE TYPE

- 2 **Appareil ou système de protection** destiné à être utilisé en atmosphères explosibles (**Directive 94/9/CE**)
- 3 Numéro de l'attestation d'examen CE de type **LCIE 11 ATEX 3027 X**
- 4 Appareil ou système de protection :
 Convertisseur de volume électronique
 Type : EK280
- 5 Demandeur : Elster GmbH
 Adresse : Steinemstrasse 19-21,
 55252 Mainz-Kastel
 Germany
- 6 Fabricant : Elster GmbH
 Adresse : Steinemstrasse 19-21,
 55252 Mainz-Kastel
 Germany
- 7 Cet appareil ou système de protection et ses variantes éventuelles acceptées sont décrits dans l'annexe de la présente attestation et dans les documents descriptifs cités en référence.
- 8 Le LCIE, organisme notifié sous la référence 0081 conformément à l'article 9 de la directive 94/9/CE du Parlement européen et du Conseil du 23 mars 1994, certifie que cet appareil ou système de protection est conforme aux exigences essentielles de sécurité et de santé pour la conception et la construction d'appareils et de systèmes de protection destinés à être utilisés en atmosphères explosibles, données dans l'annexe II de la directive. Les résultats des vérifications et essais figurent dans le rapport confidentiel N° 101963-602949.
- 9 Le respect des exigences essentielles de sécurité et de santé est assuré par la conformité à : EN 60079-0 (2009), EN 60079-11 (2007)
- 10 Le signe X lorsqu'il est placé à la suite du numéro de l'attestation, indique que cet appareil ou système de protection est soumis aux conditions spéciales pour une utilisation sûre, mentionnées dans l'annexe de la présente attestation.
- 11 Cette attestation d'examen CE de type concerne uniquement la conception et la construction de l'appareil ou du système de protection spécifié, conformément à l'annexe III de la directive 94/9/CE. Des exigences supplémentaires de la directive sont applicables pour la fabrication et la fourniture de l'appareil ou du système de protection. Ces dernières ne sont pas couvertes par la présente attestation.
- 12 Le marquage de l'appareil ou du système de protection doit comporter les informations détaillées au point 15.

1 EC TYPE EXAMINATION CERTIFICATE

- 2 **Equipment or protective system** intended for use in potentially explosive atmospheres (**Directive 94/9/EC**)
- 3 EC type examination certificate number **LCIE 11 ATEX 3027 X**
- 4 Equipment or protective system :
 Electronic Volume Conversion
 Type : EK280
- 5 Applicant : Elster GmbH
 Address : Steinemstrasse 19-21,
 55252 Mainz-Kastel
 Germany
- 6 Manufacturer : Elster GmbH
 Address : Steinemstrasse 19-21,
 55252 Mainz-Kastel
 Germany
- 7 This equipment or protective system and any acceptable variation thereto are specified in the schedule to this certificate and the documents therein referred to.
- 8 LCIE, notified body number 0081 in accordance with article 9 of the Directive 94/9/EC of the European Parliament and the Council of 23 March 1994, certifies that this equipment or protective system has been found to comply with the essential Health and Safety Requirements relating to the design and construction of equipment and protective systems intended for use in potentially explosive atmospheres, given in Annex II to the Directive. The examination and test results are recorded in confidential report N°101963-602949.
- 9 Compliance with the Essential Health and Safety Requirements has been assured by compliance with : EN 60079-0 (2009), EN 60079-11 (2007)
- 10 If the sign X is placed after the certificate number, it indicates that the equipment or protective system is subject to special conditions for safe use specified in the schedule to this certificate.
- 11 This EC type examination certificate relates only to the design and construction of this specified equipment or protective system in accordance with annex III to the directive 94/9/EC. Further requirements of the directive apply to the manufacturing process and supply of this equipment or protective system. These are not covered by this certificate.
- 12 The marking of the equipment or protective system shall include informations as detailed at 15.

Fontenay Aux Roses

2 0 AVR. 2011

Le responsable de certification ATEX
ATEX certification manager

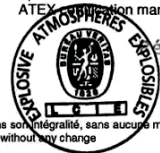

Ami HANOT

Seul le texte en français peut engager la responsabilité du LCIE. Ce document ne peut être reproduit que dans son intégralité, sans aucune modification.
The LCIE's liability applies only on the French text. This document may only be reproduced in its entirety and without any change.

Rev. A

Page 1 of 3

01-Annexe III_CE_tp_app - rev.0.DOC



L C I E



13 ANNEXE

14 ATTESTATION D'EXAMEN CE DE TYPE

LCIE 11 ATEX 3027 X

15 DESCRIPTION DE L'APPAREIL OU DU SYSTEME DE PROTECTION

Convertisseur de volume électronique
Type : EK280

Le convertisseur de volume électronique EK280 est un équipement électronique alimenté par piles. Il convertit et transmet par module radio (ECM-GW120), le volume mesuré par un compteur, en intégrant les données de température et pression.

Paramètres spécifiques du ou des modes de protection concernés :

13 SCHEDULE

14 EC TYPE EXAMINATION CERTIFICATE

LCIE 11 ATEX 3027 X

15 DESCRIPTION OF EQUIPMENT OR PROTECTIVE SYSTEM

Electronic Volume Conversion
Type : EK280

The Electronic Volume Conversion Device EK280 is a battery-powered add-on electronic device. It converts and transmits, with radio module (ECM-GW120) the volume measured by a gas meter with the help of pressure and temperature data.

Specific parameters of the mode(s) of protection concerned :

CONNECTEURS / CONNECTORS	PARAMETRES ELECTRIQUES / ELECTRICAL PARAMETERS
DE1 – DE2	$U_0 \leq 9.7V, I_0 \leq 41 mA, P_0 \leq 97.5 mW, C_i \leq 2.6 nF, L_i \leq 6 \mu H$
DE3 – DE4	$U_0 \leq 9.7V, I_0 \leq 12 mA, P_0 \leq 116 mW, C_i \leq 5.6 nF, L_i \leq 6 \mu H$
DE5 – DE6	$U_0 \leq 9.7V, I_0 \leq 1 mA, P_0 \leq 9.5 mW, C_i \leq 29.6 nF, L_i \leq 6 \mu H$

U_0, I_0, P_0 : paramètres électriques de l'équipement pouvant être raccordé aux connecteurs.

U_0, I_0, P_0 : electrical parameters of the equipment that can be connected to connectors

Le marquage doit être :

ELSTER GmbH

Adresse : ...

Type : EK280

N° de fabrication : ...

Année de fabrication : ...

Ex ia IIB T4 Ga (1)

Ex ia IIB T3 Ga (2)

LCIE 11 ATEX 3027 X

Température ambiante : - 40°C à + 60°C

 $U_i \leq \dots, I_i \leq \dots, P_i \leq \dots, C_i = \dots, L_i = \dots$ $U_0 \leq \dots, I_0 \leq \dots, P_0 \leq \dots, C_0 = \dots, L_0 = \dots$ (3)

Piles : - SAFT LS33600 ou TADIRAN SL-2880 : 3.6 V

- SLP-83111/A/072/Elster : 3.9V

(1) sans modem – radio interne.

(2) avec modem – radio interne.

(3) à compléter par les paramètres électriques, voir article 15 et 17 du certificat CE de type.

L'appareil doit également comporter le marquage normalement prévu par les normes de construction qui le concerne.

The marking shall be :

ELSTER GmbH

Address : ...

Type : EK280

Serial number : ...

Year of construction : ...

Ex ia IIB T4 Ga (1)

Ex ia IIB T3 Ga (2)

LCIE 11 ATEX 3027 X

Ambient temperature : - 40°C to + 60°C

 $U_i \leq \dots, I_i \leq \dots, P_i \leq \dots, C_i = \dots, L_i = \dots$ $U_0 \leq \dots, I_0 \leq \dots, P_0 \leq \dots, C_0 = \dots, L_0 = \dots$ (3)

Batteries : - SAFT LS33600 or TADIRAN SL-2880 : 3.6 V

- SLP-83111/A/072/Elster : 3.9V

(1) without internal radio-modem.

(2) with internal radio-modem.

(3) to complete with electrical parameters, see clause 15 and 17 of the EC type certificate..

The equipment shall also bear the usual marking required by the manufacturing standards applying to such equipment.

16 DOCUMENTS DESCRIPTIFS

Dossier de certification N° Ex-EK280_c.doc rev.00 du 25/02/2011

Ce document comprend 13 rubriques (131 pages).

16 DESCRIPTIVE DOCUMENTS

Certification file N° Ex-EK280_c.doc rev.00 dated 25/02/2011
This file includes 13 items (131 pages).

**13 ANNEXE (suite)****14 ATTESTATION D'EXAMEN CE DE TYPE**

LCIE 11 ATEX 3027 X

17 CONDITIONS SPECIALES POUR UNE UTILISATION SURE

L'appareil ne peut être alimenté que par les piles mentionnées au paragraphe 15.

Les connecteurs ne doivent être raccordés qu'à des équipements certifiés de sécurité intrinsèque. Ces associations doivent être compatibles vis-à-vis de la sécurité intrinsèque (Voir les paramètres électriques au paragraphe 15).

Les connecteurs X23 et X24 ne doivent pas être utilisés en zone explosible.

Les connecteurs X7, X15, X16, X17, X18, X28, X29 et X30 ne peuvent être connectés qu'aux capteurs définis par le fabricant dans le dossier technique (voir article 16).

Les connecteurs suivant ne peuvent être uniquement raccordés qu'à des équipements certifiés de sécurité intrinsèque conformes aux paramètres électriques maximum suivants :

Connecteur / Connector	U _o (V)	I _o (mA)	P _o (W)	C _i (nF)	L _i (mH)
Uext	30	140	0,5	0	0
DA1, DA2, DA3, DA4	30	140	0,5	0	0
DTR TxD	30	140	0,5	0	0
DCD RxD					
RI	30	140	0,5	8,9 nF	0

U_o, I_o, P_o : paramètres électriques des connecteurs d'un autre équipement ou capteur pouvant être raccordé aux connecteurs de l'équipement EK280.

U_o, I_o, P_o : electrical parameters of another equipment or sensor equipment connectors that can be connected to connectors of the EK280.

C_i, L_i : valeurs internes de capacité et d'inductance de ces connecteurs de l'EK280

C_i, L_i : EK280 internal values of capacitance and inductance on this connectors.

18 EXIGENCES ESSENTIELLES DE SECURITE ET DE SANTE

Couvertes par les normes listées au point 9.

19 VERIFICATIONS ET ESSAIS INDIVIDUELS
Néant**13 SCHEDULE (continued)****14 EC TYPE EXAMINATION CERTIFICATE**

LCIE 11 ATEX 3027 X

17 SPECIAL CONDITIONS FOR SAFE USE

The equipment can be only powered by batteries indicated clause 15.

Connectors shall be only connected to intrinsically safe certified equipments. These combinations shall be compatible as regard the intrinsic safety rules (see electrical parameters clause 15).

Connectors X23 and X24 cannot be used in hazardous area.

Connectors X7, X15, X16, X17, X18, X28, X29 and X30 can only be connected to sensors specified by the manufacturer in the technical file (see clause 16).

Following connectors can only be wired to intrinsic safety certified equipments according to the following maximum electrical parameters :

18 ESSENTIAL HEALTH AND SAFETY REQUIREMENTS

Covered by standards listed at 9.

19 ROUTINE VERIFICATIONS AND TESTS
None



L C I E

- | | |
|--|--|
| <p>1 AVENANT D'ATTESTATION D'EXAMEN CE DE TYPE</p> <p>2 Appareil ou système de protection destiné à être utilisé en atmosphères explosibles (Directive 94/9/CE)</p> <p>3 Numéro de l'avenant :
LCIE 11 ATEX 3027 X / 01</p> <p>4 Appareil ou système de protection :
Convertisseur de volume
Type : EK280</p> <p>5 Demandeur : Elster Gmbh</p> <p>15 DESCRIPTION DE L'AVENANT</p> <p>Modification de composant.</p> <p>Les résultats des vérifications et essais figurent dans le rapport confidentiel N°114997-628941.</p> <p><u>Paramètres spécifiques du ou des modes de protection concerné(s) :</u>
Modifiés pour les connecteurs DE1 et DE2 :</p> | <p>1 SUPPLEMENTARY EC TYPE EXAMINATION CERTIFICATE</p> <p>2 Equipment or protective system intended for use in potentially explosive atmospheres (Directive 94/9/EC)</p> <p>3 Supplementary certificate number :
LCIE 11 ATEX 3027 X / 01</p> <p>4 Equipment or protective system :
Electronic Volume Conversion
Type : EK280</p> <p>5 Applicant : Elster Gmbh</p> <p>15 DESCRIPTION OF THE SUPPLEMENTARY CERTIFICATE</p> <p>Modification of components.</p> <p>The examination and test results are recorded in confidential report N°114997-628941.</p> <p><u>Specific parameters of the concerned protection mode:</u>
Modified for the connectors DE1 and DE2 :</p> |
|--|--|

Connecteurs / Connectors	Paramètres électriques / Electrical parameters
DE1-DE2	$U_0 \leq 9,7V, I_0 \leq 19,7mA, P_0 \leq 47,8mW, C_i \leq 2,6nF, L_i \leq 6\mu H$
DE3-DE4	$U_0 \leq 9,7V, I_0 \leq 12mA, P_0 \leq 116mW, C_i \leq 5,6nF, L_i \leq 6\mu H$
DE5-DE6	$U_0 \leq 9,7V, I_0 \leq 1mA, P_0 \leq 9,5mW, C_i \leq 29,6nF, L_i \leq 6\mu H$

Le marquage doit être : Inchangé.

The marking shall be : Unchanged.

- | | |
|--|--|
| <p>16 DOCUMENTS DESCRIPTIFS</p> <p>Dossier de certification N°EX_EK280_1suppl_a.doc édition a / 04.07.12 du 04/07/2012.
Ce dossier comprend 2 rubriques (52 pages).</p> <p>17 CONDITIONS SPECIALES POUR UNE UTILISATION SURE
Inchangées.</p> <p>18 EXIGENCES ESSENTIELLES DE SECURITE ET DE SANTE
Inchangées.</p> <p>19 VERIFICATIONS ET ESSAIS INDIVIDUELS
Néant.</p> | <p>16 DESCRIPTIVE DOCUMENTS</p> <p>Certification file N°EX_EK280_1suppl_a.doc édition a / 04.07.12 dated 2012/07/04.
This file includes 2 items (52 pages).</p> <p>17 SPECIAL CONDITIONS FOR SAFE USE
Unchanged.</p> <p>18 ESSENTIAL HEALTH AND SAFETY REQUIREMENTS
Unchanged.</p> <p>19 ROUTINE VERIFICATIONS AND TESTS
None.</p> |
|--|--|

Fontenay-aux-Roses, le 13 juillet 2012

Le Responsable de Certification ATEX
ATEX Certification Officer
Julien Gauthier



Seul le texte en français peut engager la responsabilité du LCIE. Ce document ne peut être reproduit que dans son intégralité, sans aucune modification.
The LCIE's liability applies only on the French text. This document may only be reproduced in its entirety and without any change

Page 1 sur 1
01A-Annexe III_CE_typ_app_av - rev3 DOC



L C I E

- | | |
|---|--|
| <p>1 AVENANT D'ATTESTATION D'EXAMEN CE DE TYPE</p> <p>2 Appareil ou système de protection destiné à être utilisé en atmosphères explosibles (Directive 94/9/CE)</p> <p>3 Numéro de l'avenant :
LCIE 11 ATEX 3027 X / 02</p> <p>4 Appareil ou système de protection :
Convertisseur de volume
Type : EK280</p> <p>5 Demandeur : Elster Gmbh</p> <p>15 DESCRIPTION DE L'AVENANT</p> <p>Carte d'adaptation-modem Q24 :
Modification de composants.
Modification du circuit imprimé.
Mise à jour des documents.</p> <p>Les résultats des vérifications et essais figurent dans le rapport confidentiel N°115333-629915.</p> <p><u>Paramètres spécifiques du ou des modes de protection concerné(s) :</u>
Inchangés.</p> <p><u>Le marquage doit être :</u> Inchangé.</p> <p>16 DOCUMENTS DESCRIPTIFS</p> <p>Dossier de certification N°EX_EK280_2suppl_a.doc édition a du 26/07/2012.
Ce dossier comprend 2 rubriques (23 pages).</p> <p>17 CONDITIONS SPECIALES POUR UNE UTILISATION SURE</p> <p>Inchangées.</p> <p>18 EXIGENCES ESSENTIELLES DE SECURITE ET DE SANTE</p> <p>Inchangées.</p> <p>19 VERIFICATIONS ET ESSAIS INDIVIDUELS</p> <p>Néant.</p> | <p>1 SUPPLEMENTARY EC TYPE EXAMINATION CERTIFICATE</p> <p>2 Equipment or protective system intended for use in potentially explosive atmospheres (Directive 94/9/EC)</p> <p>3 Supplementary certificate number :
LCIE 11 ATEX 3027 X / 02</p> <p>4 Equipment or protective system :
Electronic Volume Conversion
Type : EK280</p> <p>5 Applicant : Elster Gmbh</p> <p>15 DESCRIPTION OF THE SUPPLEMENTARY CERTIFICATE</p> <p>Q24 modem-adapaterboard :
Modification of components.
Modification of the printed board.
Update of documents.</p> <p>The examination and test results are recorded in confidential report N°115333-629915.</p> <p><u>Specific parameters of the concerned protection mode:</u>
Unchanged.</p> <p><u>The marking shall be :</u> Unchanged.</p> <p>16 DESCRIPTIVE DOCUMENTS</p> <p>Certification file N°EX_EK280_2suppl_a.doc edition a dated 2012/07/26.
This file includes 2 items (23 pages).</p> <p>17 SPECIAL CONDITIONS FOR SAFE USE</p> <p>Unchanged.</p> <p>18 ESSENTIAL HEALTH AND SAFETY REQUIREMENTS</p> <p>Unchanged.</p> <p>19 ROUTINE VERIFICATIONS AND TESTS</p> <p>None.</p> |
|---|--|

Fontenay-aux-Roses, le 30 août 2012

Le Responsable de Certification ATEX
ATEX Certification Officer

émi HANOT



Seul le texte en français peut engager la responsabilité du LCIE. Ce document ne peut être reproduit que dans son intégralité, sans aucune modification.
The LCIE's liability applies only on the French text. This document may only be reproduced in its entirety and without any change.

Page 1 sur 1

01A-Annexe III_LCIE_app_av - rev3.DOC

LCIE

Laboratoire Central

des Industries Electriques

Une société de Bureau Veritas



L C I E

- | | |
|---|---|
| <p>1 AVENANT D'ATTESTATION D'EXAMEN CE DE TYPE</p> <p>2 Appareil ou système de protection destiné à être utilisé en atmosphères explosibles (Directive 94/9/CE)</p> <p>3 Numéro de l'avenant :
LCIE 11 ATEX 3027 X / 03</p> <p>4 Appareil ou système de protection :
 Convertisseur de volume
Type : EK280</p> <p>5 Demandeur : Elster GmbH</p> | <p>1 SUPPLEMENTARY EC TYPE EXAMINATION CERTIFICATE</p> <p>2 Equipment or protective system intended for use in potentially explosive atmospheres (Directive 94/9/EC)</p> <p>3 Supplementary certificate number:
LCIE 11 ATEX 3027 X / 03</p> <p>4 Equipment or protective system:
 Volume conversion device
Type: EK280</p> <p>5 Applicant: Elster GmbH</p> |
|---|---|

15 DESCRIPTION DE L'AVENANT

- Modification de valeurs de résistances.
- Mise à jour normative selon les normes EN 60079-0:2009 et EN 60079-11:2012.

Les résultats des vérifications et essais de type sont enregistrés dans le rapport confidentiel n°121241-642207-01.

Paramètres spécifiques du ou des modes de protection concerné(s).

Les piles utilisées dans l'appareil sont les suivantes :

- Elster N°73015774 (3,6 V, 13 Ah) ou N°73020663 (3,6 V, 16,5 Ah).
- Elster N°73021211 (3,9 V, 16 Ah).

15 DESCRIPTION OF THE SUPPLEMENTARY CERTIFICATE

- Modification of some resistor values.
- Normative update according to standards EN 60079-0:2009 and EN 60079-11:2012.

The results of type verifications and tests are recorded in confidential report n°121241-642207-01.

Specific parameters of the concerned protection mode:

Batteries used within the apparatus are as follows:

- Elster N°73015774 (3,6 V, 13 Ah) or N°73020663 (3,6 V, 16,5 Ah).
- Elster N°73021211 (3,9 V, 16 Ah).

Connecteur /Connector	Paramètres électriques /Electrical parameters					
Uext	U _i : 30 V	I _i : 140 mA	P _i : 0,5 W	C _i : 0	L _i : 0	
DA1, DA2, DA3, DA4	U _i : 30 V	I _i : 140 mA	P _i : 0,5 W	C _i : 13,2 nF	L _i : 6 µH	
DCD RxD	U _i : 30 V	I _i : 140 mA	P _i : 0,5 W	C _i : 0	L _i : 0	
Ri	U _i : 30 V	I _i : 140 mA	P _i : 0,5 W	C _i : 8,9 nF	L _i : 0	
DE1, DE2	U _o : 9,7 V	I _o : 19,7 mA	P _o : 48 mW	C _o : 24 µF	L _o : 367 mH	
DE3, DE4	U _o : 9,7 V	I _o : 21 mA	P _o : 51 mW	C _o : 24 µF	L _o : 322 mH	
DE5, DE6	U _o : 9,7 V	I _o : 1,0 mA	P _o : 2,4 mW	C _o : 24 µF	L _o : 142 H	
DTR TxD	U _o : 9,7 V	I _o : 87 mA	P _o : 211 mW	C _o : 24 µF	L _o : 18 mH	

Fontenay-aux-Roses, le

2 0 AOUT 2014

Le Responsable de Certification ATEX
ATEX Certification Officer
Michel EQUI

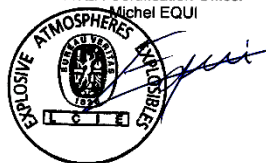

Seul le texte en français peut engager la responsabilité du LCIE. Ce document ne peut être reproduit que dans son intégralité, sans aucune modification.
The LCIE's liability applies only on the French text. This document may only be reproduced in its entirety and without any change



13 ANNEXE

14 AVENANT D'ATTESTATION D'EXAMEN CE DE TYPE

LCIE 11 ATEX 3027 X / 03

15 DESCRIPTION DE L'AVENANT (suite)

Le marquage doit être :

Elster GmbH

Adresse : ...

Type : EK280

N° de fabrication : ...

Année de fabrication : ...

II 1 G

Ex ia IIB T4 Ga (sans module-radio)

Ex ia IIB T3 Ga (avec module-radio)

LCIE 11 ATEX 3027 X

Tamb : -40°C à +60°C

U_i : ...; I_i : ...; P_i : ...; C_i : ...; L_i : ... (*)U₀ : ...; I₀ : ...; P₀ : ...; C₀ : ...; L₀ : ... (*)

AVERTISSEMENT :

- UTILISER UNIQUEMENT DES BATTERIES ELSTER

N°73015774, N°73020663, N°73021211

- DANGER POTENTIEL DE CHARGES

ELECTROSTATIQUES – VOIR INSTRUCTIONS.

(*) : voir les paramètres électriques ci-dessus.

L'appareil doit également comporter le marquage normalement prévu par les normes de construction qui le concerne.

16 DOCUMENTS DESCRIPTIFS

Dossier technique n° EE0254 rév. 1 du 13/08/2014.

Ce dossier comprend 19 rubriques (190 pages).

17 CONDITIONS SPECIALES POUR UNE UTILISATION SURE

1. Les connecteurs de sécurité intrinsèque de l'appareil ne doivent être raccordés qu'à des matériels de sécurité intrinsèque certifiés pour l'usage considéré. Cette association doit répondre aux exigences de la norme EN 60079-25.
2. Les connecteurs X23 et X24 ne doivent pas être utilisés en zone explosible.
3. Les connecteurs U₀ sur la carte Modem-adapter et X9 sur la carte CPU ne doivent pas être utilisés en zone explosible.
4. Les connecteurs X17 et X18 ne peuvent être connectés qu'aux capteurs de température définis par le fabricant dans le dossier technique (voir le paragraphe 16).

13 SCHEDULE

14 SUPPLEMENTARY EC TYPE EXAMINATION CERTIFICATE

LCIE 11 ATEX 3027 X / 03

15 DESCRIPTION OF THE SUPPLEMENTARY CERTIFICATE (continued)

The marking shall be:

Elster GmbH

Address: ...

Type: EK280

Serial number: ...

Year of construction: ...

II 1 G

Ex ia IIB T4 Ga (without radio-module)

Ex ia IIB T3 Ga (with radio-module)

LCIE 11 ATEX 3027 X

Tamb : -40°C to +60°C

U_i : ...; I_i : ...; P_i : ...; C_i : ...; L_i : ... (*)U₀ : ...; I₀ : ...; P₀ : ...; C₀ : ...; L₀ : ... (*)

WARNING:

- USE ONLY ELSTER N°73015774, N°73020663,

N°73021211 BATTERIES

- POTENTIAL ELECTROSTATIC CHARGING HAZARD -

- SEE INSTRUCTIONS.

(*) : see electrical parameters hereabove.

The equipment shall also bear the usual marking required by the manufacturing standards applying to such equipment.

16 DESCRIPTIVE DOCUMENTS

Technical file n° EE0254 rev. 1 dated 2014/08/13.

This file includes 19 items (190 pages).

17 SPECIAL CONDITIONS FOR SAFE USE

1. The intrinsically safe apparatus shall only be connected to associated intrinsically safe apparatus certified for the intended use. This association shall comply with the requirements of the standard EN 60079-25.
2. Connectors X23 and X24 cannot be used in hazardous area.
3. Connectors U₀ on Modem-adapter board and X9 in CPU board cannot be used in hazardous area.
4. Connectors X17 and X18 can only be connected to temperature sensors defined by the manufacturer in technical file (see clause 16).



L C I E

13 ANNEXE (suite)

14 AVENANT D'ATTESTATION D'EXAMEN CE DE TYPE

LCIE 11 ATEX 3027 X / 03

17 CONDITIONS SPECIALES POUR UNE UTILISATION SURE (suite)

5. Les connecteurs X7, X15, X16, X28, X29 et X30 ne peuvent être connectés qu'aux capteurs de pression définis par le fabricant dans le dossier technique (voir le paragraphe 16).

6. Paramètres électriques des connecteurs d'un autre matériel ou capteur certifié de sécurité intrinsèque pouvant être raccordé aux connecteurs de l'EK280

Electrical parameters of connectors from another intrinsically safe certified equipment or sensor that can be connected to the connectors of EK280:

Connecteur de l'EK280 Connector of EK280	Paramètres électriques des connecteurs d'un autre matériel certifié de sécurité intrinsèque <i>Electrical parameters of connectors from another intrinsically safe certified equipment or sensor</i>				
Uext	$U_0 \leq 30 \text{ V}$	$I_0 \leq 140 \text{ mA}$	$P_0 \leq 0.5 \text{ W}$	$C_0 - C_{C \text{ max}} \geq 0$	$L_0 - L_{C \text{ max}} \geq 0$
DA1, DA2, DA3, DA4	$U_0 \leq 30 \text{ V}$	$I_0 \leq 140 \text{ mA}$	$P_0 \leq 0.5 \text{ W}$	$C_0 - C_{C \text{ max}} \geq 13.2 \text{ nF}$	$L_0 - L_{C \text{ max}} \geq 6 \mu\text{H}$
DCD RxD	$U_0 \leq 30 \text{ V}$	$I_0 \leq 140 \text{ mA}$	$P_0 \leq 0.5 \text{ W}$	$C_0 - C_{C \text{ max}} \geq 0$	$L_0 - L_{C \text{ max}} \geq 0$
RI	$U_0 \leq 30 \text{ V}$	$I_0 \leq 140 \text{ mA}$	$P_0 \leq 0.5 \text{ W}$	$C_0 - C_{C \text{ max}} \leq 8.9 \text{ nF}$	$L_0 - L_{C \text{ max}} \geq 0$
DE1, DE2	$U_i \geq 9.7 \text{ V}$	$I_i \geq 19.7 \text{ mA}$	$P_i \geq 48 \text{ mW}$	$C_i + C_{C \text{ max}} \leq 24 \mu\text{F}$	$L_i + L_{C \text{ max}} \leq 367 \text{ mH}$
DE3, DE4	$U_i \geq 9.7 \text{ V}$	$I_i \geq 21 \text{ mA}$	$P_i \geq 51 \text{ mW}$	$C_i + C_{C \text{ max}} \leq 24 \mu\text{F}$	$L_i + L_{C \text{ max}} \leq 322 \text{ mH}$
DE5, DE6	$U_i \geq 9.7 \text{ V}$	$I_i \geq 1.0 \text{ mA}$	$P_i \geq 2.4 \text{ mW}$	$C_i + C_{C \text{ max}} \leq 24 \mu\text{F}$	$L_i + L_{C \text{ max}} \leq 142 \text{ H}$
DTR TxD	$U_i \geq 9.7 \text{ V}$	$I_i \geq 87 \text{ mA}$	$P_i \geq 211 \text{ mW}$	$C_i + C_{C \text{ max}} \leq 24 \mu\text{F}$	$L_i + L_{C \text{ max}} \leq 18 \text{ mH}$

$C_{C \text{ max}}$, $L_{C \text{ max}}$: valeur maximale de capacité et d'inductance du câble de liaison entre EK280 et un autre matériel certifié de sécurité intrinsèque.

$C_{C \text{ max}}$, $L_{C \text{ max}}$: maximum value of capacitance and inductance of the connected cable between EK280 and intrinsically safe certified equipment.

18 EXIGENCES ESSENTIELLES DE SECURITE ET DE SANTE

Conformité aux normes européennes EN 60079-0:2009 et EN 60079-11:2012.

19 VERIFICATIONS ET ESSAIS INDIVIDUELS

Néant.

13 SCHEDULE (continued)

14 SUPPLEMENTARY EC TYPE EXAMINATION CERTIFICATE

LCIE 11 ATEX 3027 X / 03

17 SPECIAL CONDITIONS FOR SAFE USE (continued)

5. Connectors X7, X15, X16, X28, X29 and X30 can only be connected to pressure sensors defined by the manufacturer in technical file (see clause 16).

18 ESSENTIAL HEALTH AND SAFETY REQUIREMENTS

Compliance with European standards EN 60079-0:2009 and EN 60079-11:2012.

19 ROUTINE VERIFICATIONS AND TESTS

None.



L C I E

1 AVENANT D'ATTESTATION D'EXAMEN CE DE TYPE

2 Appareil ou système de protection destiné à être utilisé en atmosphères explosibles (Directive 94/9/CE)

3 Numéro de l'avenant :
LCIE 11 ATEX 3027 X / 04

4 Appareil ou système de protection :
Convertisseur de volume
Type : EK280

5 Demandeur : Elster GmbH

15 DESCRIPTION DE L'AVENANT

- Ajout de la batterie Tekcell comme une alternative pour l'alimentation de la carte CPU.

- Mise à jour normative selon la norme EN 60079-0 :2012 + A11:2013.

Les résultats des vérifications et essais de type sont enregistrés dans le rapport confidentiel n°137850-677466-01.

Paramètres spécifiques du ou des modes de protection concernés :
Modifiés comme suit :

Les piles utilisées dans l'appareil sont les suivantes :

- carte CPU: Elster N°73015774, N°73020663 ou N°73023225.
- carte du modem radio: Elster N°73021211.

1 SUPPLEMENTARY EC TYPE EXAMINATION CERTIFICATE

2 Equipment or protective system intended for use in potentially explosive atmospheres (Directive 94/9/EC)

3 Supplementary certificate number:
LCIE 11 ATEX 3027 X / 04

4 Equipment or protective system:
Volume conversion device
Type: EK280

5 Applicant: Elster GmbH

15 DESCRIPTION OF THE SUPPLEMENTARY CERTIFICATE

- Add Tekcell battery as alternative supply for CPU board.

- Normative update according to EN 60079-0:2012 + A11:2013 standard.

The results of type verifications and tests are recorded in confidential report n°137850-677466-01.

Specific parameters of the concerned protection mode:

Modified as follows:

Batteries used within the apparatus are as follows:

- CPU board: Elster N°73015774, N°73020663 or N°73023225.
- radio-modem board: Elster N°73021211.

Connecteur /Connector	Paramètres électriques /Electrical parameters				
Uext	U_i : 30 V	I_i : 140 mA	P_i : 0.5 W	C_i : 0	L_i : 0
DA1, DA2, DA3, DA4	U_i : 30 V	I_i : 140 mA	P_i : 0.5 W	C_i : 13.2 nF	L_i : 6 µH
DCD Rx/D	U_i : 30 V	I_i : 140 mA	P_i : 0.5 W	C_i : 0	L_i : 0
Ri	U_i : 30 V	I_i : 140 mA	P_i : 0.5 W	C_i : 8.9 nF	L_i : 0
DE1, DE2	U_o : 9.7 V	I_o : 19.7 mA	P_o : 48 mW	C_o : 24 µF	L_o : 367 mH
DE3, DE4	U_o : 9.7 V	I_o : 21 mA	P_o : 51 mW	C_o : 24 µF	L_o : 322 mH
DE5, DE6	U_o : 9.7 V	I_o : 1.0 mA	P_o : 2.4 mW	C_o : 24 µF	L_o : 142 H
DTR Tx/D	U_o : 9.7 V	I_o : 87 mA	P_o : 211 mW	C_o : 24 µF	L_o : 18 mH

Fontenay-aux-Roses, le 28 janvier 2016

Le Responsable de Certification ATEX
ATEX Certification Officer
Julien Gauthier



Seul le texte en français peut engager la responsabilité de LCIE. Ce document ne peut être reproduit que dans son intégralité, sans aucune modification.
The LCIE's liability applies only on the French text. This document may only be reproduced in its entirety and without any change

Page 1 sur 3
01A-Annexe III_CE_typ_av - rev3.DOC

LCIE

Laboratoire Central

des Industries Électriques

Une société de Bureau Veritas

35, av du Général Leclerc

BP 8

92266 Fontenay-aux-Roses cedex

France

Tél : +33 1 40 95 60 60

Fax : +33 1 40 95 86 56

contact@lcie.fr

www.lcie.fr

Société par Actions Simplifiée

au capital de 15 745 984 €

RCS Nanterre B 108 363 174

11



13 ANNEXE

13 SCHEDULE

14 AVENANT D'ATTESTATION D'EXAMEN CE DE TYPE

14 SUPPLEMENTARY EC TYPE EXAMINATION CERTIFICATE

LCIE 11 ATEX 3027 X / 04

LCIE 11 ATEX 3027 X / 04

15 DESCRIPTION DE L'AVENANT (suite)

15 DESCRIPTION OF THE SUPPLEMENTARY CERTIFICATE (continued)

Le marquage doit être : Modifié comme suit

Elster GmbH
 Adresse : ...
 Type : EK280
 N° de fabrication : ...
 Année de fabrication : ...
 Ⓜ II 1 G
 Ex ia IIB T4 Ga (sans module-radio)
 Ex ia IIB T3 Ga (avec module-radio)
 LCIE 11 ATEX 3027 X
 Tamb : -40°C à +60°C
 U_i : ...; I_i : ...; P_i : ...; C_i : ...; L_i : ... (*)
 U₀ : ...; I₀ : ...; P₀ : ...; C₀ : ...; L₀ : ... (*)

AVERTISSEMENT :

- UTILISER UNIQUEMENT DES BATTERIES ELSTER
 N°73015774, N°73020663, N°73021211 et N°73023225
 - DANGER POTENTIEL DE CHARGES
 ELECTROSTATIQUES – VOIR INSTRUCTIONS.
 (*): voir les paramètres électriques ci-dessus.

L'appareil doit également comporter le marquage
 normalement prévu par les normes de construction qui le
 concerne.

The marking shall be: Modified as follows :

Elster GmbH
 Address: ...
 Type: EK280
 Serial number: ...
 Year of construction: ...
 Ⓜ II 1 G
 Ex ia IIB T4 Ga (without radio-module)
 Ex ia IIB T3 Ga (with radio-module)
 LCIE 11 ATEX 3027 X
 Tamb : -40°C to +60°C
 U_i : ...; I_i : ...; P_i : ...; C_i : ...; L_i : ... (*)
 U₀ : ...; I₀ : ...; P₀ : ...; C₀ : ...; L₀ : ... (*)

WARNING:

- USE ONLY ELSTER N°73015774, N°73020663,
 N°73021211 and N°73023225 BATTERIES
 - POTENTIAL ELECTROSTATIC CHARGING HAZARD –
 SEE INSTRUCTIONS.
 (*): see electrical parameters above.

The equipment shall also bear the usual marking required by
 the manufacturing standards applying to such equipment.

16 DOCUMENTS DESCRIPTIFS

16 DESCRIPTIVE DOCUMENTS

Dossier technique n° EE0254 Rév.1 du 11/11/2015.
 Ce dossier comprend 22 rubriques (200 pages).

Technical file n° EE0254 Rev.1 dated 2015/11/11.
 This file includes 22 items (200 pages).

17 CONDITIONS SPECIALES POUR UNE UTILISATION SURE

17 SPECIAL CONDITIONS FOR SAFE USE

1. Les connecteurs de sécurité intrinsèque de l'appareil ne
 doivent être raccordés qu'à des matériels de sécurité
 intrinsèque certifiés pour l'usage considéré. Cette
 association doit répondre aux exigences de la norme
 EN 60079-25.
 2. Les connecteurs X23 et X24 ne doivent pas être utilisés
 en zone explosible.
 3. Les connecteurs U_{ext} sur la carte Modem-adapter et X9
 sur la carte CPU ne doivent pas être utilisés en zone
 explosible.
 4. Les connecteurs X17 et X18 ne peuvent être connectés
 qu'aux capteurs de température définis par le fabricant
 dans le dossier technique (voir le paragraphe 16).

1. The intrinsically safe apparatus shall only be connected to
 associated intrinsically safe apparatus certified for the
 intended use. This association shall comply with the
 requirements of the standard EN 60079-25.

2. Connectors X23 and X24 cannot be used in hazardous
 area.
 3. Connectors U_{ext} on Modem-adaptor board and X9 in CPU
 board cannot be used in hazardous area.
 4. Connectors X17 and X18 can only be connected to
 temperature sensors defined by the manufacturer in
 technical file (see clause 16).



13 ANNEXE (suite)

13 SCHEDULE (continued)

14 AVENANT D'ATTESTATION D'EXAMEN CE DE TYPE

14 SUPPLEMENTARY EC TYPE EXAMINATION CERTIFICATE

LCIE 11 ATEX 3027 X / 04

LCIE 11 ATEX 3027 X / 04

17 CONDITIONS SPECIALES POUR UNE UTILISATION SURE (suite)

17 SPECIAL CONDITIONS FOR SAFE USE (continued)

5. Les connecteurs X7, X15, X16, X28, X29 et X30 ne peuvent être connectés qu'aux capteurs de pression définis par le fabricant dans le dossier technique (voir le paragraphe 16).

5. Connectors X7, X15, X16, X28, X29 and X30 can only be connected to pressure sensors defined by the manufacturer in technical file (see clause 16).

6. Paramètres électriques des connecteurs d'un autre matériel ou capteur certifié de sécurité intrinsèque pouvant être raccordé aux connecteurs de l'EK280 :

6. Electrical parameters of connectors from another intrinsically safe certified equipment or sensor that can be connected to the connectors of EK280:

Connecteur de l'EK280 Connector of EK280	Paramètres électriques des connecteurs d'un autre matériel certifié de sécurité intrinsèque Electrical parameters of connectors from another intrinsically safe certified equipment or sensor				
Uext	$U_0 \leq 30 \text{ V}$	$I_0 \leq 140 \text{ mA}$	$P_0 \leq 0.5 \text{ W}$	$C_0 - C_{0,max} \geq 0$	$L_0 - L_{0,max} \geq 0$
DA1, DA2, DA3, DA4	$U_0 \leq 30 \text{ V}$	$I_0 \leq 140 \text{ mA}$	$P_0 \leq 0.5 \text{ W}$	$C_0 - C_{0,max} \geq 13.2 \text{ nF}$	$L_0 - L_{0,max} \geq 6 \mu\text{H}$
DxD RxD	$U_0 \leq 30 \text{ V}$	$I_0 \leq 140 \text{ mA}$	$P_0 \leq 0.5 \text{ W}$	$C_0 - C_{0,max} \geq 0$	$L_0 - L_{0,max} \geq 0$
RI	$U_0 \leq 30 \text{ V}$	$I_0 \leq 140 \text{ mA}$	$P_0 \leq 0.5 \text{ W}$	$C_0 - C_{0,max} \geq 8.9 \text{ nF}$	$L_0 - L_{0,max} \geq 0$
DE1, DE2	$U_i \geq 9.7 \text{ V}$	$I_i \geq 19.7 \text{ mA}$	$P_i \geq 48 \text{ mW}$	$C_i + C_{0,max} \leq 24 \mu\text{F}$	$L_i + L_{0,max} \leq 367 \text{ mH}$
DE3, DE4	$U_i \geq 9.7 \text{ V}$	$I_i \geq 21 \text{ mA}$	$P_i \geq 51 \text{ mW}$	$C_i + C_{0,max} \leq 24 \mu\text{F}$	$L_i + L_{0,max} \leq 322 \text{ mH}$
DE5, DE6	$U_i \geq 9.7 \text{ V}$	$I_i \geq 1.0 \text{ mA}$	$P_i \geq 2.4 \text{ mW}$	$C_i + C_{0,max} \leq 24 \mu\text{F}$	$L_i + L_{0,max} \leq 142 \text{ H}$
DTR TxD	$U_i \geq 9.7 \text{ V}$	$I_i \geq 87 \text{ mA}$	$P_i \geq 211 \text{ mW}$	$C_i + C_{0,max} \leq 24 \mu\text{F}$	$L_i + L_{0,max} \leq 18 \text{ mH}$

$C_{0,max}$, $L_{0,max}$: valeur maximale de capacité et d'inductance du câble de liaison entre EK280 et un autre matériel certifié de sécurité intrinsèque.

$C_{0,max}$, $L_{0,max}$: maximum value of capacitance and inductance of the connected cable between EK280 and intrinsically safe certified equipment.

18 EXIGENCES ESSENTIELLES DE SECURITE ET DE SANTE

18 ESSENTIAL HEALTH AND SAFETY REQUIREMENTS

Conformité aux normes européennes EN 60079-0:2012 + A11:2013 et EN 60079-11:2012.

Compliance with European EN 60079-0:2012 + A11:2013 and EN 60079-11:2012 standards.

19 VERIFICATIONS ET ESSAIS INDIVIDUELS
Néant.19 ROUTINE VERIFICATIONS AND TESTS
None.



ATTESTATION D'EXAMEN UE DE TYPE

EU TYPE EXAMINATION CERTIFICATE



1 Version : 05

LCIE 11 ATEX 3027 X

Issue : 05

- | | | |
|--|---|---|
| <p>2 Appareil ou Système de Protection destiné à être utilisé en Atmosphères Explosibles</p> <p>3 Produit :
Convertisseur de volume</p> <p>4 Fabricant :</p> <p>5 Adresse :</p> <p>6 Ce produit et ses variantes éventuelles acceptées sont décrits dans l'annexe de la présente attestation et dans les documents descriptifs cités en référence.</p> <p>7 Le LCIE, Organisme Notifié sous la référence 0081 conformément à l'article 17 de la directive 2014/34/UE du Parlement européen et du Conseil du 26 février 2014, certifie que ce produit est conforme aux Exigences Essentielles de Sécurité et de Santé pour la conception et la construction de produits destinés à être utilisés en atmosphères explosibles, données dans l'annexe II de la Directive.
Les résultats des vérifications et essais figurent dans le(s) rapport(s) confidentiel(s) N° :</p> <p>8 Le respect des Exigences Essentielles de Sécurité et de Santé est assuré par la conformité à :</p> <p>9 Le signe « X » lorsqu'il est placé à la suite du numéro de l'attestation, indique que cet appareil est soumis aux conditions particulières d'utilisation, mentionnées dans l'annexe de cette attestation.</p> <p>10 Cette Attestation d'Examen UE de Type concerne uniquement la conception et la construction du produit spécifié.
Des exigences supplémentaires de la directive sont applicables pour la fabrication et la fourniture du produit. Ces dernières ne sont pas couvertes par la présente attestation.</p> <p>11 Le marquage du produit est mentionné dans l'annexe de cette attestation.</p> | <p>Equipment or Protective System Intended for use in Potentially Explosive Atmospheres</p> <p>Product :
Volume conversion device</p> <p>Type: EK280</p> <p>Manufacturer :
ELSTER GMBH</p> <p>Address :
Steinern Straße 19-21
55252 Mainz-Kastel
Germany</p> <p>This product any acceptable variation thereto is specified in the schedule to this certificate and the documents therein referred to.</p> <p>LCIE, Notified Body number 0081 in accordance with article 17 of the Directive 2014/34/EU of the European Parliament and the Council of 26 February 2014 certifies that product has been found to comply with the Essential Health and Safety Requirements relating to the design and construction of products intended for use in potentially explosive atmospheres, given in Annex II to the Directive.
The examination and test results are recorded in confidential report(s) N°:</p> <p>Compliance with the Essential Health and Safety Requirements has been assured by compliance with :</p> <p>If the sign "X" is placed after the certificate number, it indicates that the product is subject to the Specific Conditions of Use specified in the schedule to this certificate.</p> <p>This EU Type Examination Certificate relates only to the design and construction of the specified product.
Further requirements of the Directive apply to the manufacturing process and supply of this product. These are not covered by this certificate.</p> <p>The marking of the product is specified in the schedule to this certificate.</p> | <p>Directive 2014/34/UE</p> <p>Directive 2014/34/UE</p> |
|--|---|---|

121241-642207-01; 137850-677466-01; 144186-692011

EN 60079-0:2012 + A11:2013
EN 60079-11:2012

Fontenay-aux-Roses, le 25 novembre 2016

Responsable de Certification
Certification Officer



Seul le texte en français peut engager la responsabilité du LCIE. Ce document ne peut être reproduit que dans son intégralité, sans aucune modification. Il est établi en accord avec le référentiel de certification ATEX du LCIE. The LCIE's liability applies only on the French text. This document may only be reproduced in its entirety and without any change. It is issued in accordance with LCIE's ATEX Certification Rules.
CERT-ATEX-FORM 04 Rev. 02

Page 1 of 4

LCIE

Laboratoire Central des Industries Electriques

Une société de Bureau Veritas

33 Avenue du Général Leclerc

92260 Fontenay-aux-Roses

FRANCE

WWW.LCIE.FR



ATTESTATION D'EXAMEN UE DE TYPE - ANNEXE EU TYPE EXAMINATION CERTIFICATE - SCHEDULE

1 Version : 05

LCIE 11 ATEX 3027 X

Issue : 05

12 DESCRIPTION DU PRODUIT

L'appareil est un convertisseur de volume destiné à mesurer, enregistrer and surveiller des paramètres variables fournis par des compteurs de gaz ou des capteurs de température ou de pression.

L'appareil se compose principalement :

- d'une enveloppe en aluminium,
- d'un module LCD,
- d'une carte CPU alimentée par une source externe ou par un ou deux packs de batterie (optionnel: quatre packs de batteries montés 2x2 en série),
- d'une carte modem-adaptateur, alimentée par un pack de batterie, équipée d'un module radio interne (optionnel) et d'une antenne pour la communication sans fil des données,
- des capteurs de température ou de pression, internes ou externes,
- et des bornes pour l'alimentation ou la communication des données.

Les composants Ex suivants sont évalués dans le cadre de l'appareil :

DESCRIPTION OF PRODUCT

The equipment is a volume conversion device intended to measure, record and monitor variable parameters provided from gas meters, pressure or temperature sensors.

The equipment consists mainly of:

- an aluminum housing,
- a LCD module,
- CPU board powered by external supply or by one or two battery packs (optional: four battery packs connected 2x2 in series),
- Modem-adaptor board, powered by battery pack, equipped with internal radio-module (optional) and an antenna for wireless data communication,
- internal or external temperature or pressure sensors,
- and terminals for power supply or data communication.

The following Ex components are assessed as part of the equipment:

Désignation du produit <i>Designation of product</i>	Fabricant <i>Manufacturer</i>	Type	Document de référence <i>Document of reference</i>
Module radio / <i>Radio module</i>	Elster	ECM-GW 120	LCIE 10 ATEX 3026J
Module radio / <i>Radio module</i>	Elster	ECM-2G-UG350 ou / or ECM-3G-UU270	LCIE 16 ATEX 3047J
Fusible / <i>Fuse</i>	Littelfuse	Safe-T-Plus 0259 series	BASEEFA 02 ATEX 0071U

Paramètres spécifiques du ou des modes de protection concerné(s) :

Les piles utilisées dans l'appareil sont les suivantes :

- carte CPU: Elster N°73015774, N°73020663 ou N°73023225.
- carte modem-adaptateur: Elster N°73021211

Specific parameters of the concerned protection mode:

Batteries used within the apparatus are as follows:

- CPU board: Elster N°73015774, N°73020663 or N°73023225.
- Modem-adaptor board: Elster N°73021211

Connecteur / <i>Connector</i>	Paramètres électriques / <i>Electrical parameters</i>					
Uext	U _i : 30 V	I _i : 140 mA	P _i : 0.5 W	C _i : 0	L _i : 0	
DA1, DA2, DA3, DA4	U _i : 30 V	I _i : 140 mA	P _i : 0.5 W	C _i : 13.2 nF	L _i : 6 µH	
DCD RxD	U _i : 30 V	I _i : 140 mA	P _i : 0.5 W	C _i : 0	L _i : 0	
RI	U _i : 30 V	I _i : 140 mA	P _i : 0.5 W	C _i : 8.9 nF	L _i : 0	
DE1, DE2	U _o : 9.7 V	I _o : 19.7 mA	P _o : 48 mW	C _o : 24 µF	L _o : 367 mH	
DE3, DE4	U _o : 9.7 V	I _o : 21 mA	P _o : 51 mW	C _o : 24 µF	L _o : 322 mH	
DE5, DE6	U _o : 9.7 V	I _o : 1.0 mA	P _o : 2.4 mW	C _o : 24 µF	L _o : 142 H	
DTR TxD	U _o : 9.7 V	I _o : 87 mA	P _o : 211 mW	C _o : 24 µF	L _o : 18 mH	

DETAIL DE LA GAMME

Un seul modèle.

RANGE DETAILS

Only one model.

MARQUAGE

Le marquage du produit doit comprendre :

Elster GmbH
Adresse : ...
Type : EK280
N° de fabrication : ...
Année de fabrication : ...

MARKING

The marking of the product shall include the following :

Elster GmbH
Address: ...
Type: EK280
Serial number: ...
Year of construction: ...

Seul le texte en français peut engager la responsabilité de LCIE. Ce document ne peut être reproduit que dans son intégralité, sans aucune modification. Il est établi en accord avec le référentiel de certification ATEX de LCIE. The LCIE's liability applies only on the French text. This document may only be reproduced in its entirety and without any change. It is issued in accordance with LCIE's ATEX Certification Rules.
CERT-ATEX-FORM 04 Rev. 02

Page 2 of 4

LCIE

Laboratoire Central des Industries Electriques
Une société de Bureau Veritas

33 Avenue du Général Leclerc
92260 Fontenay-aux-Roses
FRANCE

WWW.LCIE.FR



ATTESTATION D'EXAMEN UE DE TYPE - ANNEXE

EU TYPE EXAMINATION CERTIFICATE - SCHEDULE

1 Version : 05

LCIE 11 ATEX 3027 X

Issue : 05

II 1 G

Ex ia IIB T4 Ga (sans module-radio)

Ex ia IIB T3 Ga (avec module-radio)

LCIE 11 ATEX 3027 X

Tamb : -40°C à +60°C

U_i : ...; U_o : ...; P_i : ...; C_i : ...; L_i : ...; (*)U_o : ...; I_o : ...; P_o : ...; C_o : ...; L_o : ...; (*)

AVERTISSEMENT :

- UTILISER UNIQUEMENT DES BATTERIES ELSTER

N°73015774, N°73020663, N°73021211 et N°73023225

- DANGER POTENTIEL DE CHARGES

ELECTROSTATIQUES – VOIR INSTRUCTIONS.

(*) : complété par des paramètres électriques des connecteurs

L'appareil doit également comporter le marquage normalement prévu par les normes de construction qui le concernent sous la responsabilité du fabricant.

13 CONDITIONS PARTICULIERES D'UTILISATION

- Les connecteurs de sécurité intrinsèque de l'appareil ne doivent être raccordés qu'à des appareils certifiés de sécurité intrinsèque ou à des appareils simples. Cette association doit être compatible vis-à-vis de la sécurité intrinsèque.
- Les connecteurs X23 et X24 ne doivent pas être utilisés en zone explosible.
- Les connecteurs U_{ext} sur la carte Modem-adapter et X9 sur la carte CPU ne doivent pas être utilisés en zone explosible.
- Les connecteurs X17 et X18 ne peuvent être connectés qu'aux capteurs de température définis par le fabricant dans le dossier technique.
- Les connecteurs X7, X15, X16, X28, X29 et X30 ne peuvent être connectés qu'aux capteurs de pression définis par le fabricant dans le dossier technique.
- Paramètres électriques des connecteurs d'un autre matériel ou capteur certifié de sécurité intrinsèque pouvant être raccordé aux connecteurs de l'EK280 :

Connecteur de l'EK280 Connector of EK280	Paramètres électriques des connecteurs d'un autre matériel certifié de sécurité intrinsèque Electrical parameters of connectors from another intrinsically safe certified equipment or sensor				
U _{ext}	U _o ≤ 30 V	I _o ≤ 140 mA	P _o ≤ 0,5 W	C _o - C _{o max} ≥ 0	L _o - L _{o max} ≥ 0
DA1, DA2, DA3, DA4	U _o ≤ 30 V	I _o ≤ 140 mA	P _o ≤ 0,5 W	C _o - C _{o max} ≥ 13,2 nF	L _o - L _{o max} ≤ 6 μH
DCD Rx/D	U _o ≤ 30 V	I _o ≤ 140 mA	P _o ≤ 0,5 W	C _o - C _{o max} ≥ 0	L _o - L _{o max} ≥ 0
RI	U _o ≤ 30 V	I _o ≤ 140 mA	P _o ≤ 0,5 W	C _o - C _{o max} ≥ 8,9 nF	L _o - L _{o max} ≤ 0
DE1, DE2	U _i ≥ 9,7 V	I _i ≥ 19,7 mA	P _i ≥ 48 mW	C _i + C _{o max} ≤ 24 μF	L _i + L _{o max} ≤ 367 mH
DE3, DE4	U _i ≥ 9,7 V	I _i ≥ 21 mA	P _i ≥ 51 mW	C _i + C _{o max} ≤ 24 μF	L _i + L _{o max} ≤ 322 mH
DE5, DE6	U _i ≥ 9,7 V	I _i ≥ 1,0 mA	P _i ≥ 2,4 mW	C _i + C _{o max} ≤ 24 μF	L _i + L _{o max} ≤ 142 mH
DTR Tx/D	U _i ≥ 9,7 V	I _i ≥ 87 mA	P _i ≥ 211 mW	C _i + C _{o max} ≤ 24 μF	L _i + L _{o max} ≤ 18 mH

C_{o max}, L_{o max} : valeur maximale de capacité et d'inductance du câble de liaison entre EK280 et un autre matériel certifié de sécurité intrinsèque.

C_{o max}, L_{o max} : maximum value of capacitance and inductance of the connected cable between EK280 and intrinsically safe certified equipment.

- L'enveloppe de l'appareil contient plus de 10% aluminium. Elle doit être montée de manière à éviter le risque d'étincelle par frottement ou impact.

II 1 G

Ex ia IIB T4 Ga (without radio-module)

Ex ia IIB T3 Ga (with radio-module)

LCIE 11 ATEX 3027 X

Tamb : -40°C to +60°C

U_i : ...; U_o : ...; P_i : ...; C_i : ...; L_i : ...; (*)U_o : ...; I_o : ...; P_o : ...; C_o : ...; L_o : ...; (*)

WARNING:

- USE ONLY ELSTER N°73015774, N°73020663,

N°73021211 and N°73023225 BATTERIES

- POTENTIAL ELECTROSTATIC CHARGING HAZARD –

SEE INSTRUCTIONS.

(*) : completed with electrical parameters of connectors.

The equipment shall also bear the usual marking required by the product standards applying to such equipment under the manufacturer responsibility.

SPECIFIC CONDITIONS OF USE

The intrinsically safe connectors of equipment shall only be connected to certified associated intrinsically safe equipment or simple apparatus. This combination must be compatible as regards the intrinsically safe rules.

Connectors X23 and X24 cannot be used in hazardous area.

Connectors U_{ext} on Modem-adaptor board and X9 on CPU board cannot be used in hazardous area.

Connectors X17 and X18 can only be connected to temperature sensors defined by the manufacturer in technical file.

Connectors X7, X15, X16, X28, X29 and X30 can only be connected to pressure sensors defined by the manufacturer in technical file.

Electrical parameters of connectors from another intrinsically safe certified equipment or sensor that can be connected to the connectors of EK280:

ESSENTIAL HEALTH AND SAFETY REQUIREMENTS

Covered by standards listed at 8.

14 EXIGENCES ESSENTIELLES DE SANTE ET DE SECURITE

Couvertes par les normes listées au point 8.

Seul le texte en français peut engager la responsabilité de LCIE. Ce document ne peut être reproduit que dans son intégralité, sans aucune modification. Il est établi en accord avec le référentiel de certification ATEX du LCIE. The LCIE's liability applies only on the French text. This document may only be reproduced in its entirety and without any change. It is issued in accordance with LCIE's ATEX Certification Rules.

CERT-ATEX-FORM04 Rev. 02

Page 3 of 4

LCIE

Laboratoire Central des Industries Electriques

Une société de Bureau Veritas

33 Avenue du Général Leclerc

92260 Fontenay-aux-Roses

FRANCE

WWW.LCIE.FR



ATTESTATION D'EXAMEN UE DE TYPE - ANNEXE

EU TYPE EXAMINATION CERTIFICATE - SCHEDULE

1 Version : 05

LCIE 11 ATEX 3027 X

Issue : 05

15 DOCUMENTS DESCRIPTIFS**DESCRIPTIVE DOCUMENTS**

N°	Description	Reference	Rev.	Date	Page(s)
1.	Technical file	EE0254	2	2016-11-02	288
2.	Operating manual	73021209	b	2013-10-25	91

16 INFORMATIONS COMPLEMENTAIRES**ADDITIONAL INFORMATION****Essais individuels**

Néant.

Routine tests

None.

Conditions de certification

Les détenteurs d'attestations d'examen UE de type doivent également satisfaire les exigences de contrôle de production telles que définies à l'article 13 de la Directive 2014/34/UE.

Conditions of certification

Holders of EU type examination certificates are also required to comply with the production control requirements defined in article 13 of Directive 2014/34/UE.

En accord avec l'Article 41 de la Directive 2014/34/UE, les attestations d'examen CE de type mentionnant la Directive 94/9/CE émises avant la date d'application de la Directive 2014/34/UE (20 avril 2016) peuvent être considérées comme émises en accord avec la Directive 2014/34/UE. Les nouvelles versions de ces attestations peuvent conserver le numéro de l'attestation d'origine émise avant le 20 avril 2016.

In accordance with Article 41 of Directive 2014/34/UE, EC-Type Examination Certificates referring to Directive 94/9/EC that were in existence prior to the date of application of Directive 2014/34/UE (20 April 2016) may be referenced as if they were issued in accordance with Directive 2014/34/UE. New issues of such certificates may continue to bear the original certificate number issued prior to 20 April 2016.

17 DETAILS DES MODIFICATIONS**DETAILS OF CHANGES**

Version 00 : Evaluation de la conformité selon les normes
(20/04/2011) EN 60079-0:2009 et EN 60079-11:2007.

Issue 00: Conformity assessment according to
(2011/04/20) EN 60079-0:2009 and EN 60079-11:2007 standards.

Version 01 : Modification de composants.

Issue 01: Modification of components.

Version 02 : Carte modem-adaptateur Q24 :
(13/07/2012)
(30/08/2012)

Issue 02:
(2012/07/13)
(2012/08/30)

- Modification de composants.
- Modification du circuit imprimé.
- Mise à jour des documents.
- Modification de valeurs de résistances.
- Mise à jour normative selon les normes
EN 60079-0:2009 et EN 60079-11:2012.

- Q24 modem-adapter board:
- Modification of components.
 - Modification of the printed board.
 - Update of documents.
 - Modification of some resistor values.
 - Normative update according to
EN 60079-0:2009 and EN 60079-11:2012 standards.

Version 04 : - Ajout de la batterie Tekcell comme une
(28/01/2016) alternative pour l'alimentation de la carte CPU.

Issue 04: - Addition of Tekcell battery as alternative
(2016/01/28) supply for CPU board.

- Mise à jour normative selon la norme
EN 60079-0:2012 + A11:2013.

Version 05 : Ajout d'une nouvelle carte modem-adaptateur
équipée du module radio certifié ECM-2G-
UG350 ou ECM-3G-UU270.

Issue 05: Addition of new Modem-adapter board
equipped with Ex certified radio module ECM-
2G-UG350 or ECM-3G-UU270.

Seul le texte en français peut engager la responsabilité de LCIE. Ce document ne peut être reproduit que dans son intégralité, sans aucune modification. Il est établi en accord avec le référentiel de certification ATEX du LCIE. The LCIE's liability applies only on the French text. This document may only be reproduced in its entirety and without any change. It is issued in accordance with LCIE's ATEX Certification Rules.

Page 4 of 4

LCIE

Laboratoire Central des Industries Electriques
Une société de Bureau Veritas

33 Avenue du Général Leclerc
92260 Fontenay-aux-Roses
FRANCE

WWW.LCIE.FR

9.3.2 Zone 2



L C I E

- | | |
|--|---|
| <p>1 AVENANT D'ATTESTATION D'EXAMEN DE TYPE VOLONTAIRE</p> <p>2 Appareil destiné à être utilisé en atmosphères explosibles (Directive 94/9/CE)</p> <p>3 Numéro de l'avenant :
LCIE 12 ATEX 1015 X / 01</p> <p>4 Appareil ou système de protection :
 Convertisseur de volume électronique
Type : EK280</p> <p>5 Demandeur : Elster GmbH</p> <p>15 DESCRIPTION DE L'AVENANT</p> <p>- Ajout d'un nouveau modèle protégé par les modes de protection de sécurité intrinsèque et de matériel ne produisant pas d'étincelles.
- Evaluation de la conformité suivant la norme EN 60079-11:2012.</p> <p>Les résultats des vérifications et essais de type figurent dans le rapport confidentiel N°132192-666243.</p> <p><u>Paramètres spécifiques du ou des modes de protection concerné(s).</u>
Les piles utilisées dans l'appareil sont les suivantes :
- Elster N°73015774 (3,6 V, 16,5 Ah) ou Elster N°73020663 (3,6 V, 19 Ah).
- Elster N°73017964 (3,6 V, 15 Ah).</p> <p><u>Mode de protection "nA":</u>
Alimentation principale: 90 à 230 VAC</p> <p><u>Mode de protection "nAlic":</u></p> | <p>1 VOLUNTARY SUPPLEMENTARY TYPE EXAMINATION CERTIFICATE</p> <p>2 Equipment intended for use in potentially explosive atmospheres (Directive 94/9/EC)</p> <p>3 Supplementary certificate number:
LCIE 12 ATEX 1015 X / 01</p> <p>4 Equipment or protective system:
 Electronic volume converter
Type: EK280</p> <p>5 Applicant: Elster GmbH</p> <p>15 DESCRIPTION OF THE SUPPLEMENTARY CERTIFICATE</p> <p>- Addition of new model protected by the types of protection intrinsic safety and non-sparking.
- Conformity assessment according to EN 60079-11:2012 standard.</p> <p>The examination and tests are recorded in confidential report N°132192-666243.</p> <p><u>Specific parameters of the concerned protection mode:</u>
Batteries used within the apparatus are as follows:
- Elster N°73015774 (3,6 V, 16,5 Ah) or Elster N°73020663 (3,6 V, 19 Ah).
- Elster N°73017964 (3,6 V, 15 Ah).</p> <p><u>Type of protection "nA":</u>
Main power supply: 90 to 230 VAC</p> <p><u>Type of protection "nAlic":</u></p> |
|--|---|

Connecteur /Connector	Paramètres électriques /Electrical parameters					
Alimentation principale Main power supply (L,N,PE)	U_n : 230 V	-	-	-	-	-
DA1, DA2, DA3, DA4	U_i : 30 V	I_i : 140 mA	P_i : 0,5 W	C_i : 13,2 nF	L_i : 6 µH	
DCD RxD	U_i : 30 V	I_i : 140 mA	P_i : 0,5 W	C_i : 0	L_i : 0	
RI	U_i : 30 V	I_i : 140 mA	P_i : 0,5 W	C_i : 8,9 nF	L_i : 0	
DE1, DE2	U_c : 9,7 V	I_c : 19,7 mA	P_c : 48 mW	C_c : 26 µF	L_c : 206 mH	
DE3, DE4	U_c : 9,7 V	I_c : 21 mA	P_c : 51 mW	C_c : 26 µF	L_c : 181 mH	
DE5, DE6	U_c : 9,7 V	I_c : 1,0 mA	P_c : 2,4 mW	C_c : 26 µF	L_c : 80 H	
DTR TxD	U_c : 9,7 V	I_c : 87 mA	P_c : 211 mW	C_c : 26 µF	L_c : 10 mH	

Fontenay-aux-Roses, le 27 janvier 2015

Le Responsable de Certification ATEX
ATEX Certification Officer

Julien Gauthier



Seul le texte en français peut engager la responsabilité du LCIE. Ce document ne peut être reproduit que dans sa totalité, sans aucune modification.
The LCIE's liability applies only on the French text. This document may only be reproduced in its entirety and without any modification.

Page 1 sur 4
www.Anexes III_tvo_App_01_v10-000

LCIE	55, av du Général Leclerc	Tel : +33 1 40 95 60 60	Société par Actions Simplifiée
Laboratoire Central	BP 8	Fax : +33 1 40 95 86 56	au capital de 15 715 900 €
des Industries Électriques	92266 Fontenay-aux-Roses cedex	contact@lcie.fr	RCS Nanterre B 08 363 174
Une société de Bureau Veritas	France	www.lcie.fr	

L01



13 ANNEXE

14 AVENANT D'ATTESTATION D'EXAMEN DE TYPE VOLONTAIRE

LCIE 12 ATEX 1015 X / 01

15 DESCRIPTION DE L'AVENANT (suite)

Le marquage doit être modifié comme suit :

Elster GmbH
 Adresse : ...
 Type : EK280
 N° de fabrication : ...
 Année de fabrication : ...

LCIE 12 ATEX 1015X

Ta = -25°C à +60°C

AVERTISSEMENT :

– UTILISER UNIQUEMENT DES BATTERIES ELSTER
 N°73015774, N°73020663, N°73017964
 – DANGER POTENTIAL DE CHARGES
 ELECTROSTATIQUES – VOIR INSTRUCTIONS
 – NE PAS OUVRIR EN PRESENCE D'UNE
 ATMOSPHERE EXPLOSIVE

Mode de protection "nA":

⊕ II 3 G
 Ex nA IIC T6 Gc

Mode de protection "nA[ic]":

⊕ II 3(3) G
 Ex nA[ic] IIC T6 Gc
 U_i: ..., I_i: ..., P_i: ..., C_i: ..., L_i: ..., (*)
 U_{0i}: ..., I_{0i}: ..., P_{0i}: ..., C_{0i}: ..., L_{0i}: ..., (*)
 (*): complété par les paramètres de sécurité intrinsèque.

16 DOCUMENTS DESCRIPTIFS

Dossier technique n° EE0245 rév. 2 du 07/01/2015.
 Ce dossier comprend 32 rubriques (222 pages).

17 CONDITIONS SPECIALES POUR UNE UTILISATION SURE

Mode de protection "nA":

1. Utiliser uniquement les capteurs de température et de pression, et les entrées de câble définis par le fabricant dans le dossier technique.
 2. L'appareil ne doit pas subir des chocs mécaniques d'une énergie supérieure à 2 J.

13 SCHEDULE

14 VOLUNTARY SUPPLEMENTARY TYPE EXAMINATION CERTIFICATE

LCIE 12 ATEX 1015 X / 01

15 DESCRIPTION OF THE SUPPLEMENTARY CERTIFICATE (continued)

The marking shall be modified as follows:

Elster GmbH
 Address: ...
 Type: EK280
 Serial number: ...
 Year of construction: ...

LCIE 12 ATEX 1015X

Ta = -25°C to +60°C

WARNING:

– USE ONLY ELSTER N°73015774, N°73020663,
 N°73017964 BATTERIES
 – POTENTIAL ELECTROSTATIC CHARGING HAZARD –
 SEE INSTRUCTIONS
 – DO NOT OPEN WHEN AN EXPLOSIVE ATMOSPHERE
 MAY BE PRESENT

Type of protection "nA":

⊕ II 3 G
 Ex nA IIC T6 Gc

Type of protection "nA[ic]":

⊕ II 3(3) G
 Ex nA[ic] IIC T6 Gc
 U_i: ..., I_i: ..., P_i: ..., C_i: ..., L_i: ..., (*)
 U_{0i}: ..., I_{0i}: ..., P_{0i}: ..., C_{0i}: ..., L_{0i}: ..., (*)
 (*): completed by intrinsic safety parameters.

16 DESCRIPTIVE DOCUMENTS

Technical file n° EE0245 rev. 2 dated 2015/01/07.
 This file includes 32 items (222 pages).

17 SPECIAL CONDITIONS FOR SAFE USE

Type of protection "nA":

1. Use only temperature, pressure sensors and cable glands defined by the manufacturer in technical file.
 2. The apparatus shall not be submitted to mechanical impacts with an energy above 2 J.



13 ANNEXE (suite)

14 AVENANT D'ATTESTATION D'EXAMEN DE TYPE VOLONTAIRE

LCIE 12 ATEX 1015 X / 01

17 CONDITIONS SPECIALES POUR UNE UTILISATION SURE (suite)

Mode de protection "nAlic":

1. Les connecteurs de sécurité intrinsèque de l'appareil ne doivent être raccordés qu'à des matériels de sécurité intrinsèque certifiés pour l'usage considéré. Cette association doit répondre aux exigences de la norme EN 60079-25.
2. Les connecteurs X23 et X24 ne doivent pas être utilisés en zone explosible.
3. Les connecteurs U_{int} sur la carte Modem-adaptateur et X9 sur la carte CPU ne doivent pas être utilisés en zone explosible.
4. Les connecteurs X17 et X18 ne peuvent être connectés qu'aux capteurs de température définis par le fabricant dans le dossier technique.
5. Les connecteurs X7, X15, X16, X28, X29 et X30 ne peuvent être connectés qu'aux capteurs de pression définis par le fabricant dans le dossier technique.
6. L'appareil ne doit pas subir des chocs mécaniques d'une énergie supérieure à 2 J.
7. Paramètres électriques des connecteurs d'un autre matériel ou capteur certifié de sécurité intrinsèque pouvant être raccordé aux connecteurs de l'EK280 :

Connecteur de l'EK280 Connector of EK280	Paramètres électriques des connecteurs d'un autre matériel certifié de sécurité intrinsèque Electrical parameters of connectors from another intrinsically safe certified equipment or sensor			
DA1, DA2, DA3, DA4	$U_0 \leq 30 \text{ V}$	$I_0 \leq 140 \text{ mA}$	$P_0 \leq 0.5 \text{ W}$	$C_0 - C_{0,max} \geq 13.2 \text{ nF}$ $L_0 - L_{0,max} \geq 6 \mu\text{H}$
DCD RxD	$U_0 \leq 30 \text{ V}$	$I_0 \leq 140 \text{ mA}$	$P_0 \leq 0.5 \text{ W}$	$C_0 - C_{0,max} \geq 0$ $L_0 - L_{0,max} \geq 0$
RI	$U_0 \leq 30 \text{ V}$	$I_0 \leq 140 \text{ mA}$	$P_0 \leq 0.5 \text{ W}$	$C_0 - C_{0,max} \geq 8.9 \text{ nF}$ $L_0 - L_{0,max} \geq 0$
DE1, DE2	$U_1 \geq 9.7 \text{ V}$	$I_1 \geq 19.7 \text{ mA}$	$P_1 \geq 48 \text{ mW}$	$C_1 + C_{1,max} \leq 26 \mu\text{F}$ $L_1 + L_{1,max} \leq 206 \text{ mH}$
DE3, DE4	$U_1 \geq 9.7 \text{ V}$	$I_1 \geq 21 \text{ mA}$	$P_1 \geq 51 \text{ mW}$	$C_1 + C_{1,max} \leq 26 \mu\text{F}$ $L_1 + L_{1,max} \leq 181 \text{ mH}$
DE5, DE6	$U_1 \geq 9.7 \text{ V}$	$I_1 \geq 1.0 \text{ mA}$	$P_1 \geq 2.4 \text{ mW}$	$C_1 + C_{1,max} \leq 26 \mu\text{F}$ $L_1 + L_{1,max} \leq 80 \text{ mH}$
DTR TxD	$U_1 \geq 9.7 \text{ V}$	$I_1 \geq 87 \text{ mA}$	$P_1 \geq 211 \text{ mW}$	$C_1 + C_{1,max} \leq 26 \mu\text{F}$ $L_1 + L_{1,max} \leq 10 \text{ mH}$

$C_{0,max}$, $L_{0,max}$: valeur maximale de capacité et d'inductance du câble de liaison entre EK280 et un autre matériel certifié de sécurité intrinsèque

13 SCHEDULE (continued)

14 VOLUNTARY SUPPLEMENTARY TYPE EXAMINATION CERTIFICATE

LCIE 12 ATEX 1015 X / 01

17 SPECIAL CONDITIONS FOR SAFE USE (continued)

Type of protection "nAlic":

1. The intrinsically safe apparatus shall only be connected to associated intrinsically safe apparatus certified for the intended use. This association shall comply with the requirements of the standard EN 60079-25.
2. Connectors X23 and X24 cannot be used in hazardous areas.
3. Connectors U_{int} on Modem-adaptor board and X9 in CPU board cannot be used in hazardous area.
4. Connectors X17 and X18 can only be connected to temperature sensors defined by the manufacturer in technical file.
5. Connectors X7, X15, X16, X28, X29 and X30 can only be connected to pressure sensors defined by the manufacturer in technical file.
6. The apparatus shall not be submitted to mechanical impacts with an energy above 2 J.
7. Electrical parameters of connectors from another intrinsically safe certified equipment or sensor that can be connected to the connectors of EK280.

$C_{0,max}$, $L_{0,max}$: maximum value of capacitance and inductance of the connected cable between EK280 and intrinsically safe certified equipment.

18 EXIGENCES ESSENTIELLES DE SECURITE ET DE SANTE

Couvertes par les normes EN 60079-0:2009, EN 60079-11:2012 et EN 60079-15:2010.

18 ESSENTIAL HEALTH AND SAFETY REQUIREMENTS

Covered by EN 60079-0:2009, EN 60079-11:2012 and EN 60079-15:2010 standards.



13 ANNEXE (suite)

14 AVENANT D'ATTESTATION D'EXAMEN DE TYPE VOLONTAIRE

LCIE 12 ATEX 1015 X / 01

19 VERIFICATIONS ET ESSAIS INDIVIDUELS

Chaque appareil doit être soumis à un essai de rigidité diélectrique sous 1500 V efficace conformément au paragraphe 6.5.1 de la norme EN 60079-15:2010.

13 SCHEDULE (continued)

14 VOLUNTARY SUPPLEMENTARY TYPE EXAMINATION CERTIFICATE

LCIE 12 ATEX 1015 X / 01

19 ROUTINE VERIFICATIONS AND TESTS

Each equipment shall be submitted to a dielectric strength test under 1500 V r.m.s carried out in accordance with clause 6.5.1 of EN 60079-15:2010 standard.

Seul le texte en français peut engager la responsabilité du LCIE. Ce document ne peut être reproduit que dans son intégralité, sans aucune modification.
The LCIE's liability applies only on the French text. This document may only be reproduced in its entirety and without any change

Page 4 sur 4
03A-Anneex III_typ_app_wv - rev3.DOC



L C I E

1 AVENANT D'ATTESTATION D'EXAMEN DE TYPE VOLONTAIRE

2 Appareil destiné à être utilisé en atmosphères explosibles (Directive 94/9/CE)

3 Numéro de l'avenant :
LCIE 12 ATEX 1015 X / 02

4 Appareil ou système de protection :
Convertisseur de volume électronique
Type : EK280

5 Demandeur : Elster GmbH

15 DESCRIPTION DE L'AVENANT

- Ajout de la batterie Tekcell comme une alternative pour alimentation de la carte CPU.
- Mis à jour normative selon la norme EN 60079-0 :2012 + A11 :2013.

Les résultats des vérifications et essais de type figurent dans le rapport confidentiel N°137853-677467-01

Paramètres spécifiques du ou des modes de protection concerné(s) ; Modifiés comme suit :
Les piles utilisées dans l'appareil sont les suivantes :

Batterie / Battery	Carte CPU / CPU board	Carte de modem-radio / Radio-modem board
73015774	x	
73020663	x	
73017964		x
73023225	x	

Mode de protection "nA" ;
Alimentation principale: 90 à 230 VAC

Type of protection "nA" ;
Main power supply: 90 to 230 VAC

Mode de protection "nA[ic]" :

Type of protection "nA[ic]" :

Connecteur / Connector	Paramètres électriques / Electrical parameters					
Alimentation principale Main power supply (L,N,PE)	U_n : 230 V	-	-	-	-	-
DA1, DA2, DA3, DA4	U_i : 30 V	I_i : 140 mA	P_i : 0.5 W	C_i : 13.2 nF	L_i : 6 µH	
DCD Rx/D	U_i : 30 V	I_i : 140 mA	P_i : 0.5 W	C_i : 0	L_i : 0	
RI	U_i : 30 V	I_i : 140 mA	P_i : 0.5 W	C_i : 8.9 nF	L_i : 0	
DE1, DE2	U_o : 9.7 V	I_o : 19.7 mA	P_o : 48 mW	C_o : 26 µF	L_o : 206 mH	
DE3, DE4	U_o : 9.7 V	I_o : 21 mA	P_o : 51 mW	C_o : 26 µF	L_o : 181 mH	
DE5, DE6	U_o : 9.7 V	I_o : 1.0 mA	P_o : 2.4 mW	C_o : 26 µF	L_o : 80 H	
DTR Tx/D	U_o : 9.7 V	I_o : 87 mA	P_o : 211 mW	C_o : 26 µF	L_o : 10 mH	

Fontenay-aux-Roses, le 28 janvier 2016

Le Responsable de Certification ATEX
ATEX Certification Officer
Julien Gauthier



Seul le texte en français peut engager la responsabilité de LCIE. Ce document ne peut être reproduit, ni son intégralité, sans aucune modification.
The LCIE's liability applies only on the French text. This document may only be reproduced in its entirety without any change.

Page 1 sur 3

03A-Annonce II_Lyp_app_av - rev3.DOC

LCIE
Laboratoire Central
des Industries Electriques
Une société de Bureau Veritas

33, av du Général Leclerc
BP 8
92266 Fontenay-aux-Roses cedex
France

Tel : +33 1 40 95 86 50 Société par Actions Simplifiée
Fax : +33 1 40 95 86 56 au capital de 15 745 984 €
contact@lcie.fr RCS Nanterre B 408 363 174
www.lcie.fr

10



13 ANNEXE

14 AVENANT D'ATTESTATION D'EXAMEN DE TYPE VOLONTAIRE

LCIE 12 ATEX 1015 X / 02

15 DESCRIPTION DE L'AVENANT (suite)

Le marquage doit être modifié comme suit :

Elster GmbH
 Adresse : ...
 Type : EK280
 N° de fabrication : ...
 Année de fabrication : ...

LCIE 12 ATEX 1015X

Ta = -25°C à +60°C

AVERTISSEMENT :

– UTILISER UNIQUEMENT DES BATTERIES ELSTER
 N°73015774, N°73020663, N°73017964, 73023225
 – DANGER POTENTIAL DE CHARGES
 ELECTROSTATIQUES – VOIR INSTRUCTIONS
 – NE PAS OUVRIR EN PRESENCE D'UNE
 ATMOSPHERE EXPLOSIVE

Mode de protection "nA":

⊕ II 3 G

Ex nA IIC T6 Gc

Mode de protection "nA[iC]":

⊕ II 3(3) G

Ex nA[iC] IIC T6 Gc

U_i: ...; I_i: ...; P_i: ...; C_i: ...; L_i: ...; (*)U_{0i}: ...; I_{0i}: ...; P_{0i}: ...; C_{0i}: ...; L_{0i}: ...; (*)

(*) : complété par les paramètres de sécurité intrinsèque.

16 DOCUMENTS DESCRIPTIFS

Dossier technique n° EE0245 Rév.2 du 11/11/2015.

Ce dossier comprend 35 rubriques (300 pages).

17 CONDITIONS SPECIALES POUR UNE UTILISATION SURE

Mode de protection "nA":

1. Utiliser uniquement les capteurs de température et de pression, et les entrées de câble définis par le fabricant dans le dossier technique.

2. L'appareil ne doit pas subir des chocs mécaniques d'une énergie supérieure à 2J.

13 SCHEDULE

14 VOLUNTARY SUPPLEMENTARY TYPE EXAMINATION CERTIFICATE

LCIE 12 ATEX 1015 X / 02

15 DESCRIPTION OF THE SUPPLEMENTARY CERTIFICATE (continued)

The marking shall be modified as follows:

Elster GmbH
 Address: ...
 Type: EK280
 Serial number: ...
 Year of construction: ...

LCIE 12 ATEX 1015X

Ta = -25°C to +60°C

WARNING:

– USE ONLY ELSTER N°73015774, N°73020663,
 N°73017964, 73023225 BATTERIES
 – POTENTIAL ELECTROSTATIC CHARGING HAZARD –
 SEE INSTRUCTIONS
 – DO NOT OPEN WHEN AN EXPLOSIVE ATMOSPHERE
 MAY BE PRESENT

Type of protection "nA":

⊕ II 3 G

Ex nA IIC T6 Gc

Type of protection "nA[iC]":

⊕ II 3(3) G

Ex nA[iC] IIC T6 Gc

U_i: ...; I_i: ...; P_i: ...; C_i: ...; L_i: ...; (*)U_{0i}: ...; I_{0i}: ...; P_{0i}: ...; C_{0i}: ...; L_{0i}: ...; (*)

(*) : completed by intrinsic safety parameters.

16 DESCRIPTIVE DOCUMENTS

Technical file n° EE0245 Rev.2 dated 2015/11/11.

This file includes 35 items (300 pages).

17 SPECIAL CONDITIONS FOR SAFE USE

Type of protection "nA":

1. Use only temperature, pressure sensors and cable glands defined by the manufacturer in technical file.

2. The apparatus shall not be submitted to mechanical impacts with an energy above 2J.



13 ANNEXE (suite)

14 AVENANT D'ATTESTATION D'EXAMEN DE TYPE VOLONTAIRE

LCIE 12 ATEX 1015 X / 02

17 CONDITIONS SPECIALES POUR UNE UTILISATION SURE (suite)

Mode de protection "nAlic":

1. Les connecteurs de sécurité intrinsèque de l'appareil ne doivent être raccordés qu'à des matériels de sécurité intrinsèque certifiés pour l'usage considéré. Cette association doit répondre aux exigences de la norme EN 60079-25.
2. Les connecteurs X23 et X24 ne doivent pas être utilisés en zone explosible.
3. Les connecteurs U_{ext} sur la carte Modem-adaptateur et X9 sur la carte CPU ne doivent pas être utilisés en zone explosible.
4. Les connecteurs X17 et X18 ne peuvent être connectés qu'aux capteurs de température définis par le fabricant dans le dossier technique.
5. Les connecteurs X7, X15, X16, X28, X29 et X30 ne peuvent être connectés qu'aux capteurs de pression définis par le fabricant dans le dossier technique.
6. L'appareil ne doit pas subir des chocs mécaniques d'une énergie supérieure à 2J.
7. Paramètres électriques des connecteurs d'un autre matériel ou capteur certifié de sécurité intrinsèque pouvant être raccordé aux connecteurs de l'EK280 :

Connecteur de l'EK280 <i>Connector of EK280</i>	Paramètres électriques des connecteurs d'un autre matériel certifié de sécurité intrinsèque <i>Electrical parameters of connectors from another intrinsically safe certified equipment or sensor</i>				
DA1, DA2, DA3, DA4	$U_o \leq 30 \text{ V}$	$I_o \leq 140 \text{ mA}$	$P_o \leq 0.5 \text{ W}$	$C_o - C_{c, \text{max}} \geq 13.2 \text{ nF}$	$L_o - L_{c, \text{max}} \geq 6 \mu\text{H}$
DCD Rx/D	$U_o \leq 30 \text{ V}$	$I_o \leq 140 \text{ mA}$	$P_o \leq 0.5 \text{ W}$	$C_o - C_{c, \text{max}} \geq 0$	$L_o - L_{c, \text{max}} \geq 0$
RI	$U_o \leq 30 \text{ V}$	$I_o \leq 140 \text{ mA}$	$P_o \leq 0.5 \text{ W}$	$C_o - C_{c, \text{max}} \geq 8.9 \text{ nF}$	$L_o - L_{c, \text{max}} \geq 0$
DE1, DE2	$U_i \geq 9.7 \text{ V}$	$I_i \geq 19.7 \text{ mA}$	$P_i \geq 48 \text{ mW}$	$C_i + C_{c, \text{max}} \leq 26 \mu\text{F}$	$L_i + L_{c, \text{max}} \leq 206 \text{ mH}$
DE3, DE4	$U_i \geq 9.7 \text{ V}$	$I_i \geq 21 \text{ mA}$	$P_i \geq 51 \text{ mW}$	$C_i + C_{c, \text{max}} \leq 26 \mu\text{F}$	$L_i + L_{c, \text{max}} \leq 181 \text{ mH}$
DE5, DE6	$U_i \geq 9.7 \text{ V}$	$I_i \geq 1.0 \text{ mA}$	$P_i \geq 2.4 \text{ mW}$	$C_i + C_{c, \text{max}} \leq 26 \mu\text{F}$	$L_i + L_{c, \text{max}} \leq 80 \text{ H}$
DTR Tx/D	$U_i \geq 9.7 \text{ V}$	$I_i \geq 87 \text{ mA}$	$P_i \geq 211 \text{ mW}$	$C_i + C_{c, \text{max}} \leq 26 \mu\text{F}$	$L_i + L_{c, \text{max}} \leq 10 \text{ mH}$

$C_{c, \text{max}}$, $L_{c, \text{max}}$: valeur maximale de capacité et d'inductance du câble de liaison entre EK280 et un autre matériel certifié de sécurité intrinsèque.

13 SCHEDULE (continued)

14 VOLUNTARY SUPPLEMENTARY TYPE EXAMINATION CERTIFICATE

LCIE 12 ATEX 1015 X / 02

17 SPECIAL CONDITIONS FOR SAFE USE (continued)

Type of protection "nAlic":

1. The intrinsically safe apparatus shall only be connected to associated intrinsically safe apparatus certified for the intended use. This association shall comply with the requirements of the standard EN 60079-25.
2. Connectors X23 and X24 cannot be used in hazardous area.
3. Connectors U_{ext} on Modem-adaptateur board and X9 in CPU board cannot be used in hazardous area.
4. Connectors X17 and X18 can only be connected to temperature sensors defined by the manufacturer in technical file.
5. Connectors X7, X15, X16, X28, X29 and X30 can only be connected to pressure sensors defined by the manufacturer in technical file.
6. The apparatus shall not be submitted to mechanical impacts with energy above 2J.
7. Electrical parameters of connectors from another intrinsically safe certified equipment or sensor that can be connected to the connectors of EK280:

$C_{c, \text{max}}$, $L_{c, \text{max}}$: maximum value of capacitance and inductance of the connected cable between EK280 and intrinsically safe certified equipment.

18 EXIGENCES ESSENTIELLES DE SECURITE ET DE SANTE

Couvertes par les normes EN 60079-0:2012 +A11:2013, EN 60079-11:2012 et EN 60079-15:2010.

19 VERIFICATIONS ET ESSAIS INDIVIDUELS

Chaque appareil doit être soumis à un essai de rigidité diélectrique sous $1500 V_{eff}$ conformément au paragraphe 6.5.1 de la norme EN 60079-15:2010.

18 ESSENTIAL HEALTH AND SAFETY REQUIREMENTS

Covered by EN 60079-0:2012 +A11:2013, EN 60079-11:2012 and EN 60079-15:2010 standards.

19 ROUTINE VERIFICATIONS AND TESTS

Each equipment shall be submitted to a dielectric strength test under $1500 V_{eff}$ carried out in accordance with clause 6.5.1 of EN 60079-15:2010 standard.



ATTESTATION D'EXAMEN DE TYPE TYPE EXAMINATION CERTIFICATE



1 Version : 03

LCIE 12 ATEX 1015 X

Issue : 03

<p>2 Appareil ou Système de Protection destiné à être utilisé en Atmosphères Explosibles</p> <p>3 Produit : Convertisseur de volume électronique</p> <p>4 Fabricant :</p> <p>5 Adresse :</p> <p>6 Ce produit et ses variantes éventuelles acceptées sont décrits dans l'annexe de la présente attestation et dans les documents descriptifs cités en référence.</p> <p>7 Le LCIE certifie que ce produit est conforme aux Exigences Essentielles de Sécurité et de Santé pour la conception et la construction de produits destinés à être utilisés en atmosphères explosibles, données dans l'annexe II de la Directive. Les résultats des vérifications et essais figurent dans le(s) rapport(s) confidentiel(s) N° : 109797-618988; 132192-666243; 137853-677467-01; 147881-701514-01; 147881-701514-02</p> <p>8 Le respect des Exigences Essentielles de Sécurité et de Santé est assuré par la conformité à : EN 60079-0:2012 + A11:2013 EN 60079-11:2012 EN 60079-15:2010</p> <p>9 Le signe « X » lorsqu'il est placé à la suite du numéro de l'attestation, indique que cet appareil est soumis aux conditions particulières d'utilisation, mentionnées dans l'annexe de cette attestation.</p> <p>10 Cette Attestation d'Examen de Type concerne uniquement la conception et la construction du produit spécifié. Des exigences supplémentaires de la directive sont applicables pour la fabrication et la fourniture du produit. Ces dernières ne sont pas couvertes par la présente attestation.</p> <p>11 Le marquage du produit est mentionné dans l'annexe de cette attestation.</p>	<p style="text-align: right;">Directive 2014/34/EU</p> <p>Equipment or Protective System Intended for use in Potentially Explosive Atmospheres</p> <p>Product : Volume conversion device</p> <p>Type: EK280</p> <p>Manufacturer : Elster GmbH</p> <p>Address : Steinemstrasse 19-21 55252 Mainz-Kastel Germany</p> <p>This product any acceptable variation thereto is specified in the schedule to this certificate and the documents therein referred to.</p> <p>LCIE certifies that product has been found to comply with the Essential Health and Safety Requirements relating to the design and construction of products intended for use in potentially explosive atmospheres, given in Annex II to the Directive. The examination and test results are recorded in confidential report(s) N°:</p> <p>Compliance with the Essential Health and Safety Requirements has been assured by compliance with :</p> <p>If the sign "X" is placed after the certificate number, it indicates that the product is subject to the Specific Conditions of Use specified in the schedule to this certificate.</p> <p>This Type Examination Certificate relates only to the design and construction of the specified product. Further requirements of the Directive apply to the manufacturing process and supply of this product. These are not covered by this certificate.</p> <p>The marking of the product is specified in the schedule to this certificate.</p>
---	--

Fontenay-aux-Roses, le 21 juillet 2017

Responsable de Certification

Certification Officer
Julien Gauthier

Seul le texte en français peut engager la responsabilité du LCIE. Ce document ne peut être reproduit que dans son intégralité, sans aucune modification. Il est établi en accord avec le référentiel de certification ATEX du LCIE. The LCIE's liability applies only on the French text. This document may only be reproduced in its entirety and without any change. It is issued in accordance with LCIE's ATEX Certification Rules.

Page 1 of 4

LCIE

Laboratoire Central des Industries Electriques

Une société de Bureau Veritas

33 Avenue du Général Laclerc

92260 Fontenay-aux-Roses

FRANCE

WWW.LCIE.FR



ATTESTATION D'EXAMEN DE TYPE - ANNEXE TYPE EXAMINATION CERTIFICATE - SCHEDULE

1 Version : 03

LCIE 12 ATEX 1015 X

Issue : 03

12 DESCRIPTION DU PRODUIT

L'appareil convertit et affiche le volume mesuré par un compteur de gaz en état de fonctionnement au volume standard à l'aide des variables d'état de la pression et de la température.

L'appareil se compose principalement des composants suivants:

- Boîtier en aluminium avec écran LCD et claviers
- Cartes électroniques (alimentation, CPU, modem-adaptateur avec module radio)
- Six entrées numériques (DE1 à DE6) pour capteurs passifs, quatre sorties numériques (DA1 à DA4) et interface série (DTR/T+, TxD/T-, RxD/R-, DCD/R+, Ri)
- Un ou deux capteurs de pression ou de température
- Alimentation externe ou par des piles (3.6 V)

Paramètres spécifiques des modes de protection concernés :

Les piles utilisées dans l'appareil sont les suivantes :

Pile Cell	Carte CPU CPU board	Carte modem-adaptateur Modem-adaptateur board
73015774	x	
73020663	x	
73017964		x
73023225	x	

Avec le type de protection Ex nA :
Alimentation principale: 90 à 230 VAC

Avec le type de protection Ex nA [ic] :

DESCRIPTION OF PRODUCT

The equipment converts and displays the volume measured by a gas meter in operating state to the standard volume with the aid of the state variables of pressure and temperature.

The equipment consists mainly of the following components:

- Aluminium housing with LCD display and keypads
- Electronic boards (power supply, CPU, modem-adaptateur with radio module)
- Six digital inputs (DE1 to DE6) for passive sensors, four digital outputs (DA1 to DA4) and serial interface (DTR/T+, TxD/T-, RxD/R-, DCD/R+, Ri)
- One or two pressure or temperature sensors
- Main power supply or by cells (3.6 V)

Specific parameters of the concerned protection mode:

Cells used within the equipment are as follows:

With the type of protection Ex nA:
Main power supply: 90 to 230 VAC

With the type of protection Ex nA [ic]:

Borne Terminal	Paramètres électriques Electrical parameters				
Alimentation principale (L,N,PE) Main power supply	U_m : 230 V	-	-	-	-
DA1, DA2, DA3, DA4, DTR/T+, TxD/T-, RxD/R-, DCD/R+, Ri	U_i : 30 V	I_{iC} : 140 mA	P_{iC} : 0.5 W	C_i : 0	L_i : 0
DE1, DE2	U_{iC} : 9.7 V	I_{iC} : 19.7 mA	P_{iC} : 48 mW	C_{iC} : 26 μ F	L_{iC} : 206 mH
DE3, DE4	U_{iC} : 9.7 V	I_{iC} : 21 mA	P_{iC} : 51 mW	C_{iC} : 26 μ F	L_{iC} : 181 mH
DE5, DE6	U_{iC} : 9.7 V	I_{iC} : 1.0 mA	P_{iC} : 2.4 mW	C_{iC} : 26 μ F	L_{iC} : 80 H

DETAIL DE LA GAMME

Un seul modèle. L'appareil peut être utilisé comme appareil protégé par Ex nA ou par Ex nA [ic].

MARQUAGE

Le marquage du produit doit comprendre :

Elster GmbH ou Elster
Adresse : ...
Type : EK280
N° de fabrication : ...
Année de fabrication : ...
LCIE 12 ATEX 1015 X
Ta = -25°C à +60°C

RANGE DETAILS

Only one model. The equipment might be used as equipment protection either by Ex nA or by Ex nA [ic].

MARKING

The marking of the product shall include the following :

Elster GmbH or Elster
Address: ...
Type: EK280
Serial number: ...
Year of construction: ...
LCIE 12 ATEX 1015 X
Ta = -25°C to +60°C

Seul le texte en français peut engager la responsabilité de LCIE. Ce document ne peut être reproduit que dans son intégralité, sans aucune modification. Il est établi en accord avec le [référéntiel de certification ATEX](#) de LCIE. The LCIE's liability applies only on the French text. This document may only be reproduced in its entirety and without any change. It is issued in accordance with LCIE's [ATEX Certification Rules](#).
CERT-ATEX-FORM 05 Rev. 02

Page 2 of 4

LCIE

Laboratoire Central des Industries Electriques
Une société de Bureau Veritas

33 Avenue du Général Lecterc
92260 Fontenay-aux-Roses
FRANCE

WWW.LCIE.FR



ATTESTATION D'EXAMEN DE TYPE - ANNEXE TYPE EXAMINATION CERTIFICATE - SCHEDULE

1 Version : 03

LCIE 12 ATEX 1015 X

Issue : 03

AVERTISSEMENT :

- UTILISER UNIQUEMENT DES BATTERIES ELSTER N°73015774, N°73020663, N°73017964 et 73023225
- DANGER POTENTIAL DE CHARGES ELECTROSTATIQUES – VOIR INSTRUCTIONS
- NE PAS OUVRIR EN PRESENCE D'UNE ATMOSPHERE EXPLOSIVE

Avec le type de protection Ex nA :

Ⓔ II 3 G

Ex nA IIC T6 Gc

Avec le type de protection Ex nA [ic] :

Ⓔ II 3(3) G

Ex nA [ic] IIC T6 Gc

U: ..., I: ..., P: ..., C: ..., L: ..., (*)

Uo: ..., Io: ..., Po: ..., Co: ..., Lo: ..., (*)

(*) : complété par les paramètres de sécurité intrinsèque.

L'appareil doit également comporter le marquage normalement prévu par les normes de construction qui le concernent sous la responsabilité du fabricant.

13 CONDITIONS PARTICULIERES D'UTILISATION**Avec le type de protection Ex nA :**

- a. Utiliser uniquement les capteurs de température et de pression, et les entrées de câble définis par le fabricant dans le dossier technique.

- b. L'appareil ne doit pas subir des chocs mécaniques d'une énergie supérieure à 2J.

Avec le type de protection Ex nA [ic] :

- a. Les connecteurs de sécurité intrinsèque de l'appareil ne doivent être raccordés qu'à des matériels de sécurité intrinsèque certifiés pour l'usage considéré. Cette association doit répondre aux exigences de la norme EN 60079-25.

- b. Les connecteurs X23 et X24 ne doivent pas être utilisés en zone explosible.

- c. Les connecteurs U_{ext} sur la carte Modem-adapter et X9 sur la carte CPU ne doivent pas être utilisés en zone explosible.

- d. Les connecteurs X17 et X18 ne peuvent être connectés qu'aux capteurs de température définis par le fabricant dans le dossier technique.

- e. Les connecteurs X7, X15, X16, X28, X29 et X30 ne peuvent être connectés qu'aux capteurs de pression définis par le fabricant dans le dossier technique.

- f. L'appareil ne doit pas subir des chocs mécaniques d'une énergie supérieure à 2J.

- g. Paramètres électriques des bornes d'un matériel associé certifié de sécurité intrinsèque ou d'une sonde pouvant être raccordé aux bornes de l'EK280 :

WARNING:

- USE ONLY ELSTER N°73015774, N°73020663, N°73017964 and 73023225 BATTERIES
- POTENTIAL ELECTROSTATIC CHARGING HAZARD – SEE INSTRUCTIONS
- DO NOT OPEN WHEN AN EXPLOSIVE ATMOSPHERE IS PRESENT

With the type of protection Ex nA :

Ⓔ II 3 G

Ex nA IIC T6 Gc

With the type of protection Ex nA [ic] :

Ⓔ II 3(3) G

Ex nA [ic] IIC T6 Gc

U: ..., I: ..., P: ..., C: ..., L: ..., (*)

Uo: ..., Io: ..., Po: ..., Co: ..., Lo: ..., (*)

(*) : completed by intrinsic safety parameters.

The equipment shall also bear the usual marking required by the product standards applying to such equipment under the manufacturer responsibility.

SPECIFIC CONDITIONS OF USE**With the type of protection Ex nA :**

Use only temperature, pressure sensors and cable glands defined by the manufacturer in technical file.

The apparatus shall not be submitted to mechanical impacts with an energy above 2J.

With the type of protection Ex nA [ic] :

The intrinsically safe apparatus shall only be connected to associated intrinsically safe apparatus certified for the intended use. This association shall comply with the requirements of EN 60079-25 standard.

Connectors X23 and X24 cannot be used in hazardous area.

Connectors U_{ext} on Modem-adapter board and X9 in CPU board cannot be used in hazardous area.

Connectors X17 and X18 can only be connected to temperature sensors defined by the manufacturer in technical file.

Connectors X7, X15, X16, X28, X29 and X30 can only be connected to pressure sensors defined by the manufacturer in technical file.

The apparatus shall not be submitted to mechanical impacts with energy above 2J.

Electrical parameters of terminals from associated intrinsically safe certified equipment or sensor that can be connected to the terminals of EK280:

Seul le texte en français peut engager la responsabilité de LCIE. Ce document ne peut être reproduit que dans son intégralité, sans aucune modification. Il est établi en accord avec le référentiel de certification ATEX de LCIE. The LCIE's liability applies only on the French text. This document may only be reproduced in its entirety and without any change. It is issued in accordance with LCIE's ATEX Certification Rules.

Page 3 of 4

LCIE

Laboratoire Central des Industries Electriques
Une société de Bureau Veritas

33 Avenue du Général Leclerc
92260 Fontenay-aux-Roses
FRANCE

WWW.LCIE.FR



ATTESTATION D'EXAMEN DE TYPE - ANNEXE TYPE EXAMINATION CERTIFICATE - SCHEDULE

1 Version : 03

LCIE 12 ATEX 1015 X

Issue : 03

Bornes de l'EK280 <i>Terminals of EK280</i>	Paramètres électriques de l'appareil associé de sécurité intrinsèque ou d'une sonde <i>Electrical parameters of associated intrinsically safe certified equipment or sensor</i>				
DA1, DA2, DA3, DA4, DTR/T+, TxD/T-, RxD/R-, DCD/R+, RI	$U_0 \leq 30 \text{ V}$	$I_{0T} \leq 140 \text{ mA}$	$P_{0T} \leq 0.5 \text{ W}$	$C_0 - C_{0\text{max}} \geq 0$	$L_0 - L_{0\text{max}} \geq 0$
DE1, DE2	$U_i \geq 9.7 \text{ V}$	$I_i \geq 19.7 \text{ mA}$	$P_i \geq 48 \text{ mW}$	$C_i + C_{i\text{max}} \leq 26 \mu\text{F}$	$L_i + L_{i\text{max}} \leq 206 \text{ mH}$
DE3, DE4	$U_i \geq 9.7 \text{ V}$	$I_i \geq 21 \text{ mA}$	$P_i \geq 51 \text{ mW}$	$C_i + C_{i\text{max}} \leq 26 \mu\text{F}$	$L_i + L_{i\text{max}} \leq 181 \text{ mH}$
DE5, DE6	$U_i \geq 9.7 \text{ V}$	$I_i \geq 1.0 \text{ mA}$	$P_i \geq 2.4 \text{ mW}$	$C_i + C_{i\text{max}} \leq 26 \mu\text{F}$	$L_i + L_{i\text{max}} \leq 80 \text{ H}$

$C_{0\text{max}}$, $L_{0\text{max}}$: valeur maximale de capacité et d'inductance du câble de liaison entre EK280 et un matériel associé certifié de sécurité intrinsèque.

$C_{0\text{max}}$, $L_{0\text{max}}$: maximum value of capacitance and inductance of the connected cable between EK280 and an associated intrinsically safe certified equipment.

14 EXIGENCES ESSENTIELLES DE SANTE ET DE SECURITE**ESSENTIAL HEALTH AND SAFETY REQUIREMENTS**

Couvertes par les normes listées au point 8.

Covered by standards listed at 8.

15 DOCUMENTS DESCRIPTIFS**DESCRIPTIVE DOCUMENTS**

N°	Description	Reference	Rev.	Date	Page(s)
1.	Manuel d'utilisation / <i>Operating manual</i>	73021209	c	2016/11/03	157
2.	Dossier technique / <i>Technical file</i>	EE0245	3	2017/06/07	244

16 INFORMATIONS COMPLEMENTAIRES**ADDITIONAL INFORMATION****Essais individuels****Routine tests**

Chaque appareil doit être soumis à un essai de rigidité diélectrique sous 1500 V efficace conformément au paragraphe 6.5.1 de la norme EN 60079-15:2010.

Each apparatus shall be submitted to a dielectric strength test under 1500 Vrms carried out in accordance with clause 6.5.1 of EN 60079-15:2010 standard.

17 DETAILS DES MODIFICATIONS**DETAILS OF CHANGES**

Version 00: Evaluation de la conformité suivant les normes 25/09/2012 EN 60079-0:2009 et EN 60079-15:2010.

Issue 00: Conformity assessment according to 2012/09/25 EN 60079-0:2009 and EN 60079-15:2010 standards.

Version 01: 27/01/2015 - Ajout d'un nouveau modèle Ex nA [ic] protégé par sécurité intrinsèque et sans étincelles.
- Evaluation de la conformité suivant la norme EN 60079-11:2012.

Issue 01: 2015/01/27 - Addition of new model Ex nA [ic] protected by intrinsic safety and non-sparking.
- Conformity assessment according to EN 60079-11:2012 standard.

Version 02: 28/01/2016 - Ajout de la pile Tekcell comme alimentation alternative pour la carte CPU.
- Mis à jour normative selon la norme EN 60079-0:2012 + A11:2013.
- Correction de la capacité nominale des piles.

Issue 02: 2016/01/28 - Addition of Tekcell cell as alternative supply for CPU board.
- Normative update according to EN 60079-0:2012 + A11:2013 standard.
- Correction of the nominal capacity of the cells.

Version 03: - Ajout de deux nouveaux modules radio (ECM-2G-UG350 et ECM-3G-UU270) assemblés sur une nouvelle carte modem-adaptateur.
- Mise à jour des paramètres de sécurité intrinsèque pour les bornes d'interface série du modèle protégé par Ex nA [ic].

Issue 03: - Addition of two new radio-modules (ECM-2G-UG350 and ECM-3G-UU270) assembled on a new modem-adaptator board.
- Update of intrinsic safety parameters for serial interface terminals of model protected by Ex nA [ic].

Seul le texte en français peut engager la responsabilité du LCIE. Ce document ne peut être reproduit que dans son intégralité, sans aucune modification. Il est établi en accord avec le [règlement de certification ATEX](#) du LCIE. The LCIE's liability applies only on the French text. This document may only be reproduced in its entirety and without any change. It is issued in accordance with LCIE's [ATEX Certification Rules](#).
CERT-ATEX-FORM 05 Rev. 02

Page 4 of 4